



OWNER'S MANUAL

YZ85 MOTORCYCLE

 Read this manual carefully before operating this vehicle.



WARNING: Operating, servicing and maintaining a passenger vehicle or off-road vehicle can expose you to chemicals including engine exhaust, carbon monoxide, phthalates, and lead, which are known to the State of California to cause cancer and birth defects or other reproductive harm. To minimize exposure, avoid breathing exhaust, do not idle the engine except as necessary, service your vehicle in a well-ventilated area and wear gloves or wash your hands frequently when servicing your vehicle. For more information go to www.P65Warnings.ca.gov/passenger-vehicle



Read this manual carefully before operating the vehicle. This manual should stay with the vehicle if it is sold.

Congratulations on your purchase of the Yamaha YZ85L. This model is the result of Yamaha's vast experience in the production of fine sporting, touring, and pace-setting racing machines. It represents the high degree of craftsmanship and reliability that have made Yamaha a leader in these fields.

This manual will give you an understanding of the operation, inspection, and basic maintenance of this motorcycle. If you have any questions concerning the operation or maintenance of your motorcycle, please consult a Yamaha dealer.

Yamaha continually seeks advancements in product design and quality. Therefore, while this manual contains the most current product information available at the time of printing, there may be minor discrepancies between your motorcycle and this manual. If there is any question concerning this manual, please consult a Yamaha dealer.

EWA14462

 WARNING

Please read this manual, the “TIPS AND PRACTICE GUIDE FOR THE OFF HIGHWAY MOTORCYCLIST” and the “PARENTS, YOUNGSTERS AND OFF-HIGHWAY MOTORCYCLES” booklets carefully and completely before operating or allowing your child to operate this motorcycle. Do not attempt to operate this motorcycle until you have attained adequate knowledge of its controls and operating features and until you have been trained in safe and proper riding techniques. Regular inspections and careful maintenance, along with good riding skills, will ensure that you safely enjoy the capabilities and the reliability of this motorcycle.

EWA14352

 WARNING

This motorcycle is designed and manufactured for off-road use only. It is illegal to operate this motorcycle on any public street, road or highway. Such use is prohibited by law. This motorcycle complies with almost all state off-highway noise level and spark arrester laws and regulations. Please check your local riding laws and regulations before operating this motorcycle.

AN IMPORTANT SAFETY MESSAGE:

- Read this manual, the “PARENTS, YOUNGSTERS AND OFF-HIGHWAY MOTORCYCLES” booklet, and the “TIPS AND PRACTICE GUIDE FOR THE OFF HIGHWAY MOTORCYCLIST” booklet carefully and completely before operating this motorcycle. Make sure you understand all instructions.
- Pay close attention to the warning and notice labels on the motorcycle.
- Never operate a motorcycle without proper training or instruction.

Introduction

AN IMPORTANT NOTE TO PARENTS:

This motorcycle is not a toy. Before you let your child ride this motorcycle, you should understand the instructions and warnings in this Owner's Manual. Then be sure your child understands and will follow them. Also read the "PARENTS, YOUNGSTERS AND OFF-HIGHWAY MOTORCYCLES" and the "TIPS AND PRACTICE GUIDE FOR THE OFF HIGHWAY MOTORCYCLIST" booklets supplied with this motorcycle when new or available from your Yamaha dealer. Children differ in skills, physical abilities, and judgment. Some children may not be able to operate a motorcycle safely. Parents should supervise their child's use of the motorcycle at all times. Parents should permit continued use only if they determine that the child has the ability to operate the motorcycle safely.

Motorcycles are single track vehicles. Their safe use and operation are dependent upon the use of proper riding techniques as well as the expertise of the operator. Every operator should know the following requirements before riding this motorcycle.





He or she should:

- Obtain thorough instructions from a competent source on all aspects of motorcycle operation.
- Observe the warnings and maintenance requirements in this Owner's Manual.
- Obtain qualified training in safe and proper riding techniques.
- Obtain professional technical service as indicated in this Owner's Manual and/or when made necessary by mechanical conditions.

Important manual information

EAU63350

Particularly important information is distinguished in this manual by the following notations:

	This is the safety alert symbol. It is used to alert you to potential personal injury hazards. Obey all safety messages that follow this symbol to avoid possible injury or death.
	A WARNING indicates a hazardous situation which, if not avoided, could result in death or serious injury.
	A NOTICE indicates special precautions that must be taken to avoid damage to the vehicle or other property.
	A TIP provides key information to make procedures easier or clearer.

*Product and specifications are subject to change without notice.

EAU10194

**YZ85L
OWNER'S MANUAL
©2020 by Yamaha Motor Corporation, U.S.A.
1st edition, February 2019
All rights reserved.
Any reprinting or unauthorized use
without the written permission of
Yamaha Motor Corporation, U.S.A.
is expressly prohibited.
Printed in Japan.
P/N LIT-11626-33-03**

Table of contents

Location of important labels	1-1	Transmission oil	7-7
Safety information	2-1	Coolant.....	7-8
Description	3-1	Cleaning the air filter element	7-10
Left view	3-1	Adjusting the carburetor	7-12
Right view.....	3-2	Adjusting the engine idling speed	7-13
Controls and instruments.....	3-3	Adjusting the throttle grip free play	7-13
Instrument and control functions ...	4-1	Tires	7-14
Handlebar switch.....	4-1	Spoke wheels.....	7-16
Clutch lever	4-1	Adjusting the clutch lever free play	7-17
Shift pedal	4-2	Checking the brake lever free play	7-18
Brake lever.....	4-2	Checking the shift pedal	7-18
Brake pedal	4-3	Checking the front and rear brake pads.....	7-19
Fuel tank cap.....	4-3	Checking the brake fluid level.....	7-20
Fuel.....	4-4	Changing the brake fluid.....	7-21
Fuel tank breather hose.....	4-6	Drive chain slack.....	7-21
Fuel cock	4-7	Cleaning and lubricating the drive chain	7-23
Starter (choke) knob	4-7	Checking and lubricating the cables	7-23
Kickstarter	4-8	Checking and lubricating the throttle grip and cable	7-24
Seat	4-8	Checking and lubricating the brake and clutch levers	7-24
Adjusting the front fork.....	4-9	Checking and lubricating the brake pedal.....	7-25
Front fork bleeding	4-11	Lubricating the rear suspension....	7-25
Adjusting the shock absorber assembly.....	4-12	Lubricating the swingarm pivots...	7-26
Removable sidestand.....	4-15	Checking the front fork	7-26
YPVS system.....	4-16	Checking the steering	7-27
For your safety – pre-operation checks	5-1	Checking the wheel bearings.....	7-27
Operation and important riding points	6-1	Supporting the motorcycle	7-28
Engine break-in	6-1	Front wheel	7-28
Starting and warming up a cold engine	6-3	Rear wheel	7-29
Starting a warm engine	6-3	Troubleshooting	7-31
Shifting	6-4	Troubleshooting chart.....	7-32
Parking	6-5		
Periodic maintenance and adjustment	7-1	Motorcycle care and storage	8-1
Periodic maintenance and lubrication chart	7-2	Matte color caution	8-1
Checking the spark plug	7-6	Care.....	8-1
		Storage.....	8-4

Table of contents

Specifications	9-1
Consumer information	10-1
Identification numbers.....	10-1
YAMAHA MOTOR CORPORATION, U.S.A. 2020 AND LATER MODEL YZ/WR MOTORCYCLE LIMITED WARRANTY	10-2
Index	11-1

Location of important labels

EAU63360

1

Read and understand all of the labels on your vehicle. They contain important information for safe and proper operation of your vehicle. Never remove any labels from your vehicle. If a label becomes difficult to read or comes off, a replacement label is available from your Yamaha dealer.

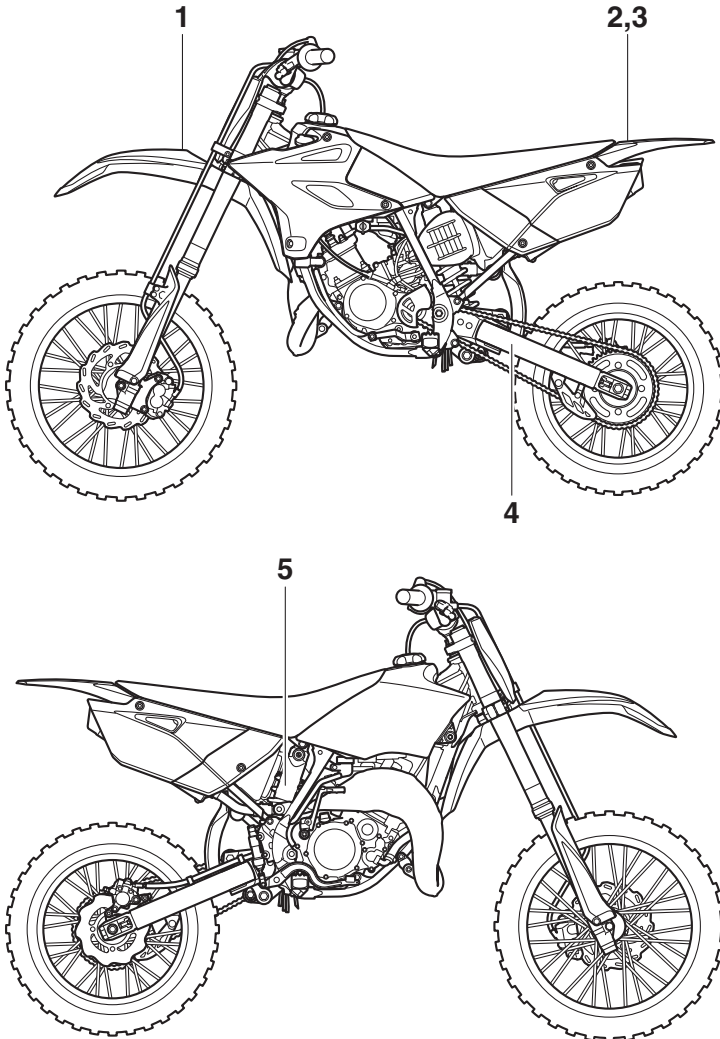

Location of important labels

1

Use premium unleaded gasoline/oil premix only.

3XJ-2415E-A1.

2

WARNING

- BEFORE YOU OPERATE THIS VEHICLE, READ THE OWNER'S MANUAL AND ALL LABELS.
- NEVER CARRY A PASSENGER. You increase your risk of losing control if you carry a passenger.
- NEVER OPERATE THIS VEHICLE ON PUBLIC ROADS. You can collide with another vehicle if you operate this vehicle on a public road.
- ALWAYS WEAR AN APPROVED MOTORCYCLE HELMET, eye protection, and protective clothing.
- EXPERIENCED RIDER ONLY.

5PA-2118K-00

3

For use only on a closed course in sanctioned competition.

This motorcycle does not meet EPA noise and emissions standards and is not for general off-road recreational riding.

17D-2812P-00

4

TIRE INFORMATION

Cold tire normal pressure should be set as follows.

FRONT : 100kPa, {1.00kgf/cm²}, 15psi

REAR : 100kPa, {1.00kgf/cm²}, 15psi

3RV-21668-A0

5

WARNING

This unit contains high pressure nitrogen gas. Mishandling can cause explosion.

- Read owner's manual for instructions.
- Do not incinerate, puncture or open.

4AA-22259-80

1

Be a Responsible Owner

As the vehicle's owner, you are responsible for the safe and proper operation of your motorcycle.

Motorcycles are single-track vehicles. Their safe use and operation are dependent upon the use of proper riding techniques as well as the expertise of the operator. Every operator should know the following requirements before riding this motorcycle.

He or she should:

- Obtain thorough instructions from a competent source on all aspects of motorcycle operation.
- Observe the warnings and maintenance requirements in this Owner's Manual.
- Obtain qualified training in safe and proper riding techniques.
- Obtain professional technical service as indicated in this Owner's Manual and/or when made necessary by mechanical conditions.
- Never operate a motorcycle without proper training or instruction. Take a training course. Beginners should receive training from a certified instructor. Contact an authorized motorcycle dealer to find out about the training courses nearest you.

Safe Riding

Perform the pre-operation checks each time you use the vehicle to make sure it is in safe operating condition. Failure to inspect or maintain the vehicle properly increases the possibility of

an accident or equipment damage. See page 5-1 for a list of pre-operation checks.

- This motorcycle is designed for off-road use only, therefore, it is illegal to operate it on public streets, roads, or highways, even a dirt or gravel one. Off-road use on public lands may be illegal. Please check local regulations before riding.
- This motorcycle is designed to carry the operator only. No passengers.
- The failure of motorists to detect and recognize motorcycles in traffic is the predominating cause of automobile/motorcycle accidents. Many accidents have been caused by an automobile driver who did not see the motorcycle. Making yourself conspicuous appears to be very effective in reducing the chance of this type of accident.

Therefore:

- Wear a brightly colored jacket.
- Use extra caution when you are approaching and passing through intersections, since intersections are the most likely places for motorcycle accidents to occur.
- Ride where other motorists can see you. Avoid riding in another motorist's blind spot.
- Never maintain a motorcycle without proper knowledge. Contact an authorized motorcycle dealer to inform you on ba-

sic motorcycle maintenance. Certain maintenance can only be carried out by certified staff.

- Many accidents involve inexperienced operators.
 - Make sure that you are qualified and that you only lend your motorcycle to other qualified operators.
 - Know your skills and limits. Staying within your limits may help you to avoid an accident.
 - We recommend that you practice riding your motorcycle until you have become thoroughly familiar with the motorcycle and all of its controls.
- Many accidents have been caused by error of the motorcycle operator. A typical error made by the operator is veering wide on a turn due to excessive speed or undercornering (insufficient lean angle for the speed). Never travel faster than warranted by conditions.
- Ride cautiously in unfamiliar areas. You may encounter hidden obstacles that could cause an accident.
- The posture of the operator is important for proper control. The operator should keep both hands on the handlebar and both feet on the operator footrests during operation to maintain control of the motorcycle.
- Never ride under the influence of alcohol or other drugs.
- Be sure the transmission is in neutral before starting the engine.

Protective Apparel

The majority of fatalities from motorcycle accidents are the result of head injuries. The use of a safety helmet is the single most critical factor in the prevention or reduction of head injuries.

- Always wear an approved helmet.
- Wear a face shield or goggles. Wind in your unprotected eyes could contribute to an impairment of vision that could delay seeing a hazard.
- The use of a jacket, heavy boots, trousers, gloves, etc., is effective in preventing or reducing abrasions or lacerations.
- Never wear loose-fitting clothes, otherwise they could catch on the control levers, footrests, or wheels and cause injury or an accident.
- Always wear protective clothing that covers your legs, ankles, and feet. The engine or exhaust system become very hot during or after operation and can cause burns.

Avoid Carbon Monoxide Poisoning

All engine exhaust contains carbon monoxide, a deadly gas. Breathing carbon monoxide can cause headaches, dizziness, drowsiness, nausea, confusion, and eventually death.

Carbon Monoxide is a colorless, odorless, tasteless gas which may be present even if you do not see or smell any engine exhaust. Deadly levels of carbon monoxide can collect rapidly and you can quickly be overcome and unable to save yourself. Also, deadly levels of carbon monoxide can linger for hours or days in enclosed or poorly

Safety information

2

ventilated areas. If you experience any symptoms of carbon monoxide poisoning, leave the area immediately, get fresh air, and SEEK MEDICAL TREATMENT.

- Do not run engine indoors. Even if you try to ventilate engine exhaust with fans or open windows and doors, carbon monoxide can rapidly reach dangerous levels.
- Do not run engine in poorly ventilated or partially enclosed areas such as barns, garages, or carports.
- Do not run engine outdoors where engine exhaust can be drawn into a building through openings such as windows and doors.

Genuine Yamaha Accessories

Choosing accessories for your vehicle is an important decision. Genuine Yamaha accessories, which are available only from a Yamaha dealer, have been designed, tested, and approved by Yamaha for use on your vehicle.

Many companies with no connection to Yamaha manufacture parts and accessories or offer other modifications for Yamaha vehicles. Yamaha is not in a position to test the products that these aftermarket companies produce. Therefore, Yamaha can neither endorse nor recommend the use of accessories not sold by Yamaha or modifications not specifically recommended by Yamaha, even if sold and installed by a Yamaha dealer.

Aftermarket Parts, Accessories, and Modifications

While you may find aftermarket products similar in design and quality to genuine Yamaha accessories, recognize that some aftermarket accessories or modifications are not suitable because of potential safety hazards to you or others. Installing aftermarket products or having other modifications performed to your vehicle that change any of the vehicle's design or operation characteristics can put you and others at greater risk of serious injury or death. You are responsible for injuries related to changes in the vehicle.

Keep the following guidelines in mind, as well as those provided under "Loading" when mounting accessories.

- Never install accessories that would impair the performance of your motorcycle. Carefully inspect the accessory before using it to make sure that it does not in any way reduce ground clearance or cornering clearance, limit suspension travel, steering travel or control operation.
- Accessories fitted to the handlebar or the front fork area can create instability due to improper weight distribution. If accessories are added to the handlebar or front fork area, they must be as lightweight as possible and should be kept to a minimum.
- Bulky or large accessories may seriously affect the stability of the motorcycle. Wind may at-

tempt to lift the motorcycle, or the motorcycle may become unstable in cross winds.

- Certain accessories can displace the operator from his or her normal riding position. This improper position limits the freedom of movement of the operator and may limit control ability, therefore, such accessories are not recommended.
- Use caution when adding electrical accessories. If electrical accessories exceed the capacity of the motorcycle's electrical system, an electric failure could result, which could cause a dangerous loss of lights or engine power.

Aftermarket Tires and Rims

The tires and rims that came with your motorcycle were designed to match the performance capabilities and to provide the best combination of handling, braking, and comfort. Other tires, rims, sizes, and combinations may not be appropriate. Refer to page 7-14 for tire specifications and more information on replacing your tires.

Transporting the Motorcycle

Be sure to observe following instructions before transporting the motorcycle in another vehicle.

- Remove all loose items from the motorcycle.
- Check that the fuel cock (if equipped) is in the "OFF" position and that there are no fuel leaks.

- Point the front wheel straight ahead on the trailer or in the truck bed, and choke it in a rail to prevent movement.
- Shift the transmission in gear (for models with a manual transmission).
- Secure the motorcycle with tie-downs or suitable straps that are attached to solid parts of the motorcycle, such as the frame or upper front fork triple clamp (and not, for example, to rubber-mounted handlebars or turn signals, or parts that could break). Choose the location for the straps carefully so the straps will not rub against painted surfaces during transport.
- The suspension should be compressed somewhat by the tie-downs, if possible, so that the motorcycle will not bounce excessively during transport.

Description

EAU63371

Left view

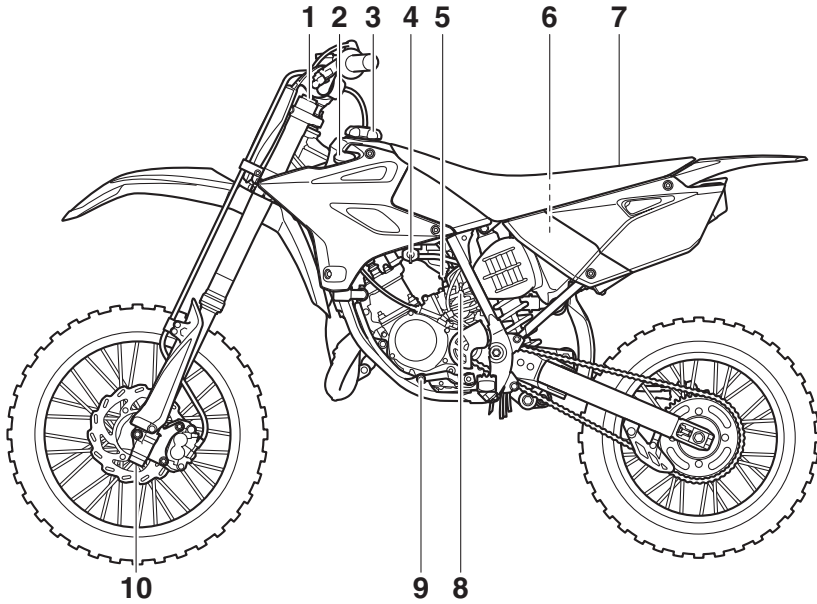

1. Rebound damping force adjuster (page 4-9)
2. Radiator cap (page 7-8)
3. Fuel tank cap (page 4-3)
4. Fuel cock (page 4-7)
5. Starter (choke) knob (page 4-7)
6. Air filter element (page 7-10)
7. Seat (page 4-8)
8. Throttle stop screw (page 7-13)
9. Shift pedal (page 4-2)
10. Compression damping force adjuster (page 4-9)

Right view

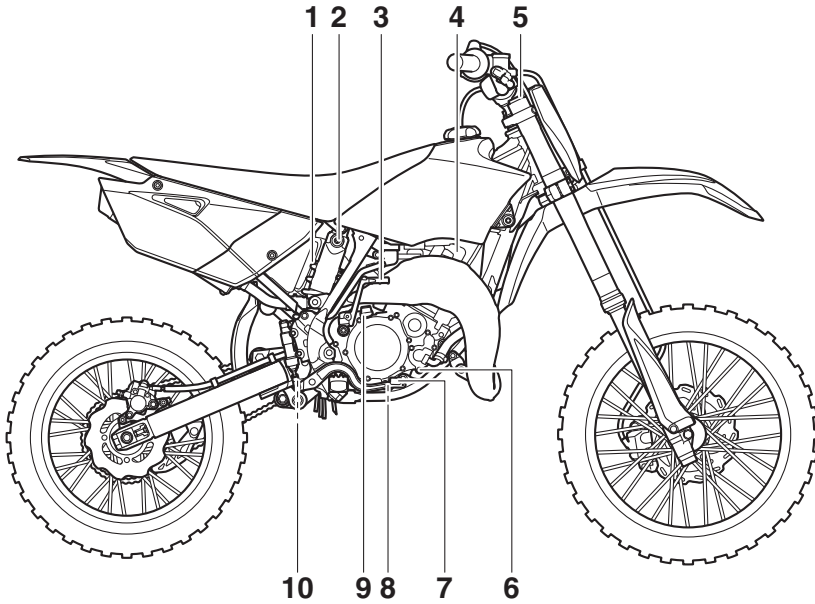

1. Spring preload adjuster (page 4-12)
2. Compression damping force adjuster (page 4-12)
3. Kickstarter (page 4-8)
4. Spark plug cap (page 7-6)
5. Bleed screw (page 4-11)
6. Coolant drain bolt (page 7-9)
7. Brake pedal (page 4-3)
8. Transmission oil drain bolt (page 7-7)
9. Transmission oil filler cap (page 7-7)
10. Rebound damping force adjuster (page 4-12)

Description

EAU63401

Controls and instruments

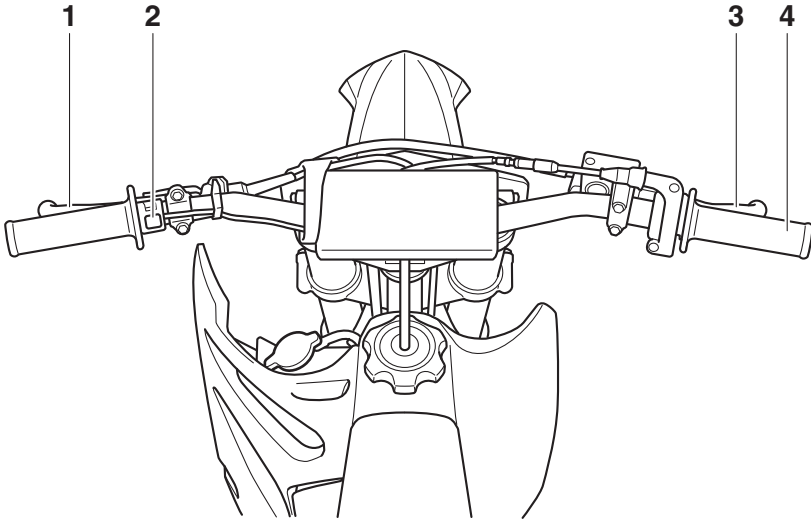

1. Clutch lever (page 4-1)
2. Engine stop switch (page 4-1)
3. Brake lever (page 4-2)
4. Throttle grip (page 7-13)

Handlebar switch

EAU40661

EAU64023

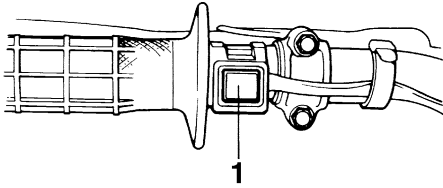

1. Engine stop switch "ENGINE STOP"

Engine stop switch "ENGINE STOP"

EAU53962

Hold this switch pushed until the engine stops.

Clutch lever

The clutch lever is located on the left side of the handlebar. To disengage the clutch, pull the lever toward the handlebar grip. To engage the clutch, release the lever. The lever should be pulled rapidly and released slowly for smooth clutch operation.

The clutch lever is equipped with a clutch lever position adjusting bolt. Adjust the distance between the clutch lever and the handlebar grip as follows.

1. Loosen the locknut.
2. While holding the clutch lever pulled slightly towards the handlebar grip, turn the adjusting bolt in direction (a) to increase the distance, and in direction (b) to decrease it.

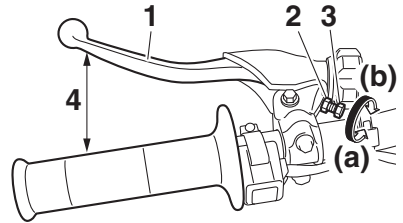

1. Clutch lever
 2. Locknut
 3. Clutch lever position adjusting bolt
 4. Distance between clutch lever and handlebar grip
3. Tighten the locknut.

Shift pedal

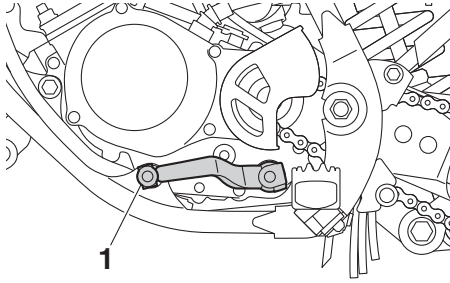

1. Shift pedal

4

The shift pedal is located on the left side of the motorcycle. To shift the transmission to a higher gear, move the shift pedal up. To shift the transmission to a lower gear, move the shift pedal down. (See page 6-4.)

Brake lever

The brake lever is located on the right side of the handlebar. To apply the front brake, pull the lever toward the throttle grip.

The brake lever is equipped with a brake lever position adjusting bolt. Adjust the distance between the brake lever and the throttle grip as follows.

1. Slide the rubber cover toward the end of the brake lever.
2. Loosen the locknut.
3. While holding the lever pushed away from the throttle grip, turn the adjusting bolt in direction (a) to increase the distance, and in direction (b) to decrease it.

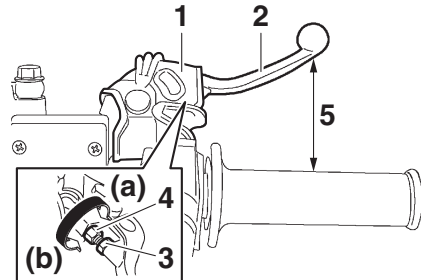

1. Rubber cover
2. Brake lever
3. Locknut
4. Brake lever position adjusting bolt
5. Distance between brake lever and throttle grip

4. Tighten the locknut.
5. Slide the rubber cover to its original position.

Brake pedal

EAU12944

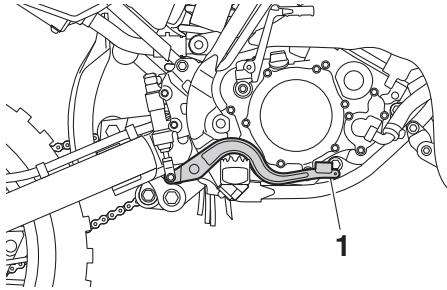

1. Brake pedal

The brake pedal is located on the right side of the motorcycle. To apply the rear brake, press down on the brake pedal.

Fuel tank cap

EAU13183

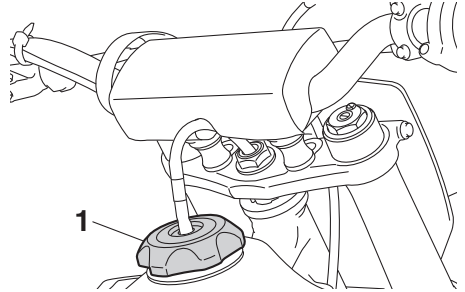

1. Fuel tank cap

To remove the fuel tank cap, turn it counterclockwise, and then pull it off. To install the fuel tank cap, insert it into the tank opening, and then turn it clockwise.

4

EWA11092

WARNING

Make sure that the fuel tank cap is properly closed after filling fuel. Leaking fuel is a fire hazard.

Instrument and control functions

Fuel

EAU41838

This motorcycle has been designed to use a premixed fuel of gasoline and 2-stroke engine oil. Always mix the gasoline and oil in a clean container before filling the fuel tank.

ECA15602

NOTICE

Always use fresh gasoline, and fill the fuel tank with a fresh mix just before riding. Do not use premixed fuel that is more than a few hours old.

Mixing gasoline and 2-stroke engine oil

Pour 2-stroke engine oil into a clean container, and then add gasoline. To mix the fuel thoroughly, shake the container from side to side.

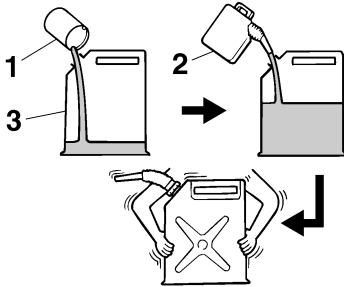

1. 2-stroke engine oil
2. Gasoline
3. Container

Recommended fuel:

Premium unleaded gasoline (E10 acceptable)

Recommended 2-stroke engine oil:
YAMALUBE 2R

Fuel tank capacity:

5.0 L (1.3 US gal, 1.1 Imp.gal)

Mixing ratios (gasoline to oil):

Break-in period: 15:1

After break-in: 30:1

Why Yamalube

YAMALUBE oil is a Genuine YAMAHA Part born of the engineers' passion and belief that engine oil is an important liquid engine component. We form teams of specialists in the fields of mechanical engineering, chemistry, electronics and track testing, and have them develop the engine together with the oil it will use. Yamalube oils take full advantage of the base oil's qualities and blend in the ideal balance of additives to make sure the final oil clears our performance standards. Thus, Yamalube mineral, semisynthetic and synthetic oils have their own distinct characters and value. Yamaha's experience gained over many years of research and development into oil since the 1960's helps make Yamalube the best choice for your Yamaha engine.

YAMALUBE®

If the recommended 2-stroke engine oil is not available, use an equivalent high-quality oil.

ECA15552

NOTICE

Never mix two brands of 2-stroke engine oil in the same batch. Always use the same type of oil to ensure maximum engine performance.

Should it be necessary to use a different oil brand, be sure to drain the fuel tank and the carburetor float chamber of the old premixed fuel prior to filling with the new type.

Instrument and control functions

EWA10882

Gasoline

This model's engine is designed to use premium unleaded gasoline with a pump octane number [(R+M)/2] of 91 or higher, or a research octane number (RON) of 95 or higher. If knocking or pinging occurs, try a gasoline of a different brand.

ECA15591

NOTICE

Use only unleaded gasoline. The use of leaded gasoline will cause severe damage to internal engine parts, such as the piston rings as well as to the exhaust system.

Gasohol

There are two types of gasohol: gasohol containing ethanol and that containing methanol. Gasohol containing ethanol can be used if the ethanol content does not exceed 10% (E10). Gasohol containing methanol should not be used as it can cause engine or fuel system problems.

Filling the fuel tank

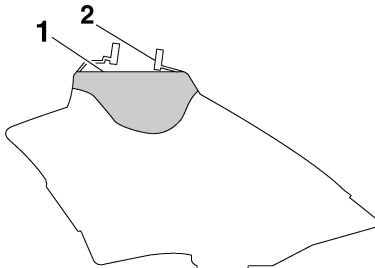

1. Maximum fuel level
2. Fuel tank filler tube

WARNING

Gasoline and gasoline vapors are extremely flammable. To avoid fires and explosions and to reduce the risk of injury when refueling, follow these instructions.

1. Before refueling, turn off the engine and be sure that no one is sitting on the vehicle. Never refuel while smoking, or while in the vicinity of sparks, open flames, or other sources of ignition such as the pilot lights of water heaters and clothes dryers.
2. Do not overfill the fuel tank. Stop filling when the fuel reaches the bottom of the filler tube. Because fuel expands when it heats up, heat from the engine or the sun can cause fuel to spill out of the fuel tank.
3. Wipe up any spilled fuel immediately. **NOTICE: Immediately wipe off spilled fuel with a clean, dry, soft cloth, since fuel may deteriorate painted surfaces or plastic parts.** [ECA10072]
4. Be sure to securely close the fuel tank cap.

EWA15152

WARNING

Gasoline is poisonous and can cause injury or death. Handle gasoline with care. Never siphon gasoline by mouth. If you should swallow some gasoline or inhale a lot of gasoline vapor, or get some gasoline in your eyes, see your doctor immediately. If gasoline spills on your skin, wash

Instrument and control functions

with soap and water. If gasoline spills on your clothing, change your clothes.

EAU41362

Fuel tank breather hose

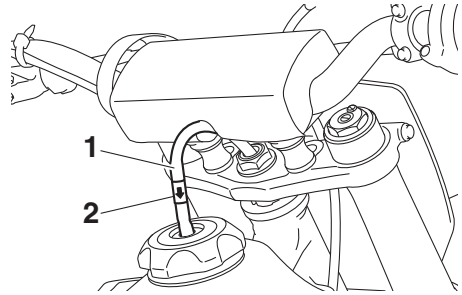

1. Fuel tank breather hose
2. One-way valve

Before operating the motorcycle:

- Check the fuel tank breather hose connection.
- Check the fuel tank breather hose for cracks or damage, and replace it if necessary.
- Make sure that the end of the fuel tank breather hose is not blocked, and clean it if necessary.

TIP _____

If the fuel tank breather hose falls out, reinstall it on the fuel tank cap with the arrow mark on the one-way valve pointed downward as shown.

Fuel cock

The fuel cock supplies fuel from the tank to the carburetor while filtering it also.

The fuel cock has two positions:

OFF

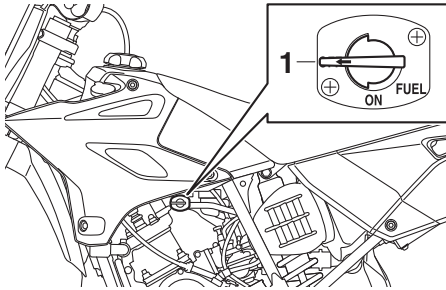

1. Arrow mark positioned over "OFF"

With the lever in this position, fuel will not flow. Always return the lever to this position when the engine is not running.

ON

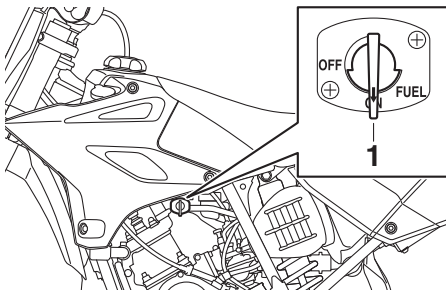

1. Arrow mark positioned over "ON"

With the lever in this position, fuel flows to the carburetor. Normal riding is done with the lever in this position.

Starter (choke) knob

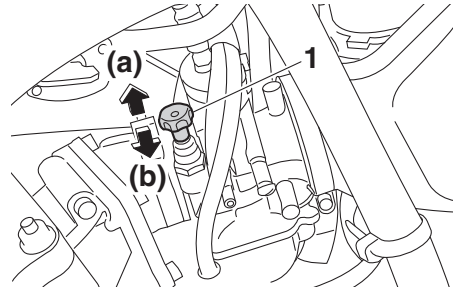

1. Starter (choke) knob

Starting a cold engine requires a richer air-fuel mixture, which is supplied by the starter (choke).

Move the knob in direction (a) to turn on the starter (choke).

Move the knob in direction (b) to turn off the starter (choke).

Instrument and control functions

EAU13651

EAU46283

Kickstarter

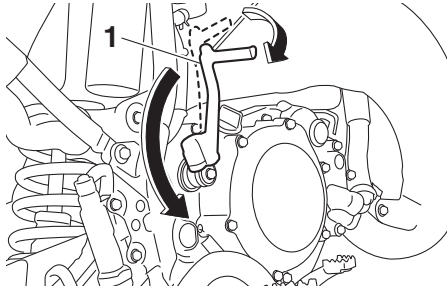

1. Kickstarter lever

4

To start the engine, fold out the kickstarter lever, move it down lightly with your foot until the gears engage, and then push it down smoothly but forcefully. This model is equipped with a primary kickstarter, allowing the engine to be started in any gear if the clutch is disengaged. However, shifting the transmission into the neutral position before starting is recommended.

Seat

To remove the seat

Remove the bolts, and then slide the seat to the rear and pull upward.

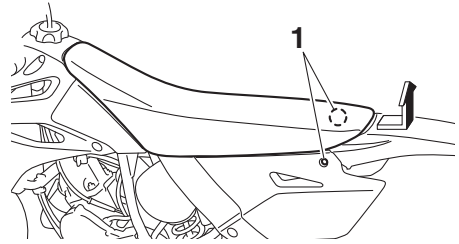

1. Bolt

To install the seat

1. Fit the slot in the seat onto the projection on the fuel tank, and insert the projection on the seat into the seat holder as shown.

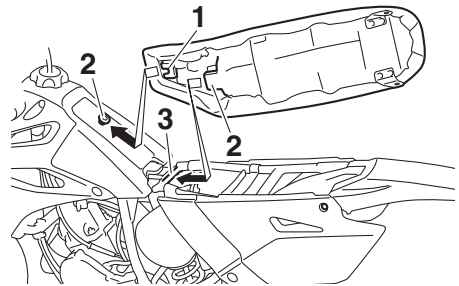

1. Slot
2. Projection
3. Seat holder

2. Place the seat in the original position, and then tighten the bolts.

TIP

Make sure that the seat is properly secured before riding.

Instrument and control functions

Adjusting the front fork

EAU84382

EWA10181

WARNING

Always adjust both fork legs equally, otherwise poor handling and loss of stability may result.

This front fork is equipped with rebound damping force adjusting screws and compression damping force adjusting screws.

ECA10102

NOTICE

To avoid damaging the mechanism, do not attempt to turn beyond the maximum or minimum settings.

Rebound damping force

1. Remove the protector.

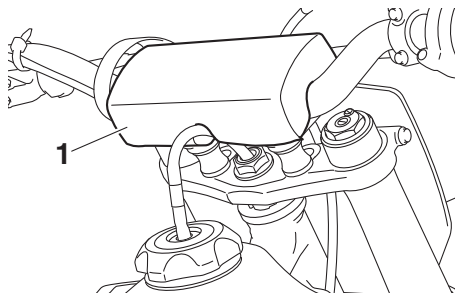

1. Protector

2. Turn the adjusting screw in direction (a) to increase the rebound damping force. Turn the adjusting screw in direction (b) to decrease the rebound damping force. To set the rebound damping force, turn the adjuster in direction (a) until it stops, and then count the clicks in direction (b).

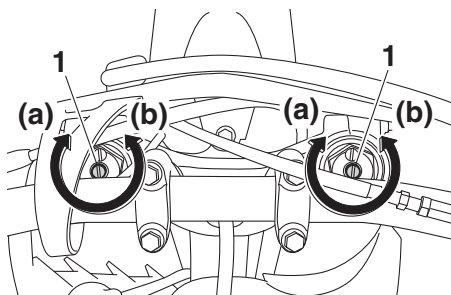

1. Rebound damping force adjusting screw

Rebound damping setting:

Minimum (soft):

20 click(s) in direction (b)

Standard:

7 click(s) in direction (b)

Maximum (hard):

1 click(s) in direction (b)

3. Install the protector.

TIP

- Install the protector so that the side with the notch is facing rearward.
- When turning the damping force adjuster in direction (a), the 0 click position and the 1 click position may be the same.
- When turning the damping force adjuster in direction (b), it may click beyond the stated specifications, however such adjustments are ineffective and may damage the suspension.

Instrument and control functions

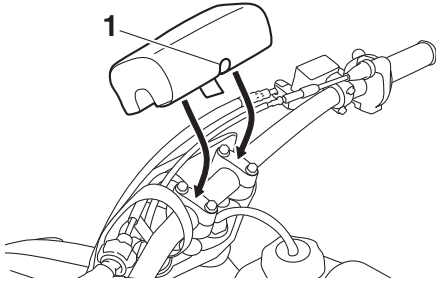

1. Notch

Compression damping force

1. Remove the rubber cap by pulling it out of the front fork leg.
2. Turn the adjusting screw in direction (a) to increase the compression damping force. Turn the adjusting screw in direction (b) to decrease the compression damping force. To set the compression damping force, turn the adjuster in direction (a) until it stops, and then count the clicks in direction (b).

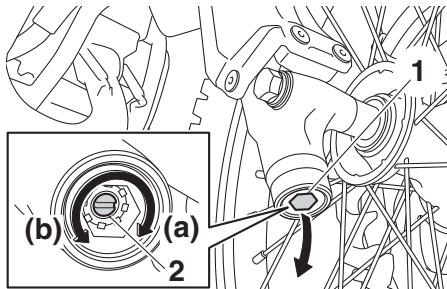

1. Rubber cap
2. Compression damping force adjusting screw

Compression damping setting:

- Minimum (soft):
20 click(s) in direction (b)
- Standard:
12 click(s) in direction (b)
- Maximum (hard):
1 click(s) in direction (b)

3. Install the rubber cap.

TIP

- When turning the damping force adjuster in direction (a), the 0 click position and the 1 click position may be the same.
- When turning the damping force adjuster in direction (b), it may click beyond the stated specifications, however such adjustments are ineffective and may damage the suspension.

EAU84390

Front fork bleeding

When riding in extremely rough conditions, the air temperature and pressure in the front fork will rise. This will increase the spring preload and harden the front suspension. If this occurs, bleed the air from each front fork leg.

EWA10201

WARNING

Always bleed both fork legs, otherwise poor handling and loss of stability may result.

To bleed the front fork legs

1. Remove the protector.

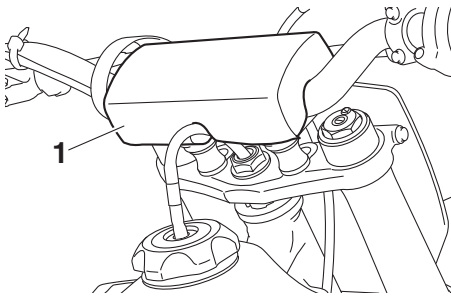

1. Protector

2. Place the motorcycle on a suitable stand. (See page 7-28.)
3. Make sure the front wheel is off the ground and the area near the bleed screws is clean.
4. Remove the bleed screws.

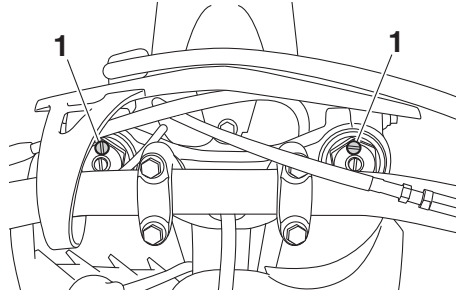

1. Bleed screw

5. Wait a few seconds, and then install the bleed screws.
6. Install the protector.

Instrument and control functions

EAU41339

Adjusting the shock absorber assembly

This shock absorber assembly is equipped with a spring preload adjusting nut, a rebound damping force adjusting screw and a compression damping force adjusting screw.

ECA10102

NOTICE

To avoid damaging the mechanism, do not attempt to turn beyond the maximum or minimum settings.

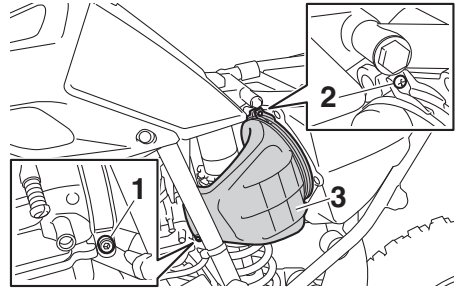

1. Clamp bolt
2. Clamp screw
3. Air filter joint

4. Loosen the locknut.
5. Turn the adjusting nut in direction (a) to increase the spring preload. Turn the adjusting nut in direction (b) to decrease the spring preload.

Spring preload

Adjust the spring preload as follows.

1. Remove the seat. (See page 4-8.)
2. Remove the bolt, and then take the left side panel off.

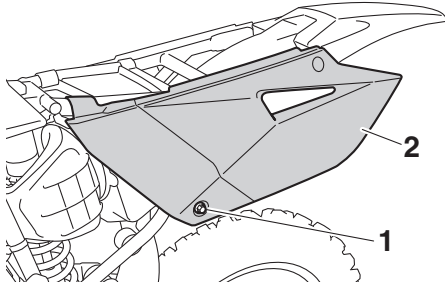

1. Bolt
2. Left side panel

3. Loosen the clamp bolt and clamp screw, and then remove the air filter joint.

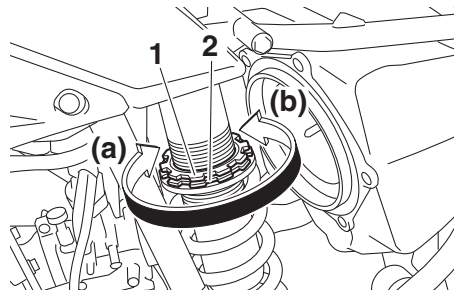

1. Locknut
2. Spring preload adjusting nut

- A special wrench can be obtained at a Yamaha dealer to make this adjustment.
- The spring preload setting is determined by measuring distance A, shown in the illustration. The longer distance A is, the lower the spring preload; the shorter distance A is, the higher the spring preload. With each complete

Instrument and control functions

turn of the adjusting nut, distance A is changed by 1.5 mm (0.06 in).

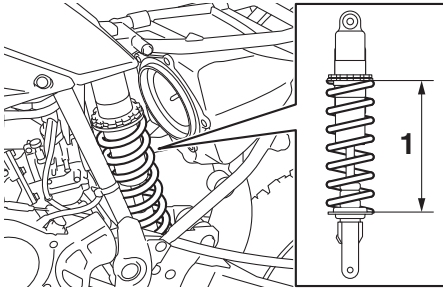

1. Distance A

Spring preload:

Minimum (soft):

Distance A = 218.5 mm (8.60 in)

Standard:

Distance A = 215.0 mm (8.46 in)

Maximum (hard):

Distance A = 202.0 mm (7.95 in)

6. Tighten the locknut to the specified torque. **NOTICE: Always tighten the locknut against the adjusting nut, and then tighten the locknut to the specified torque.** [ECA10122]

Tightening torque:

Locknut:

30 N·m (3.0 kgf·m, 22 lb·ft)

7. Install the air filter joint in its original position, and then tighten the clamp screw and clamp bolt.

TIP

Align the projection on the air filter joint with the projection on the frame guide.

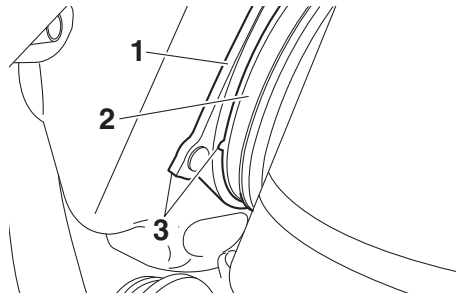

1. Frame guide
2. Air filter joint
3. Projection

8. Place the left side panel in its original position, and then install the bolt.
9. Install the seat.

Rebound damping force

Turn the adjusting screw in direction (a) to increase the rebound damping force.

Turn the adjusting screw in direction (b) to decrease the rebound damping force.

To set the rebound damping force, turn the adjuster in direction (a) until it stops, and then count the clicks in direction (b).

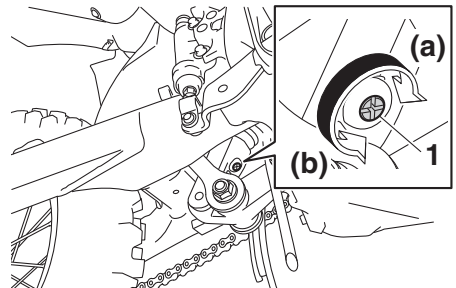

1. Rebound damping force adjusting screw

Instrument and control functions

Rebound damping setting:

- Minimum (soft):
20 click(s) in direction (b)
- Standard:
6 click(s) in direction (b)
- Maximum (hard):
1 click(s) in direction (b)

Compression damping setting:

- Minimum (soft):
15 click(s) in direction (b)
- Standard:
9 click(s) in direction (b)
- Maximum (hard):
1 click(s) in direction (b)

TIP

- When turning the damping force adjuster in direction (a), the 0 click position and the 1 click position may be the same.
- When turning the damping force adjuster in direction (b), it may click beyond the stated specifications, however such adjustments are ineffective and may damage the suspension.

TIP

- When turning the damping force adjuster in direction (a), the 0 click position and the 1 click position may be the same.
- When turning the damping force adjuster in direction (b), it may click beyond the stated specifications, however such adjustments are ineffective and may damage the suspension.

EWA10222

Compression damping force

Turn the adjusting screw in direction (a) to increase the compression damping force.

Turn the adjusting screw in direction (b) to decrease the compression damping force.

To set the compression damping force, turn the adjuster in direction (a) until it stops, and then count the clicks in direction (b).

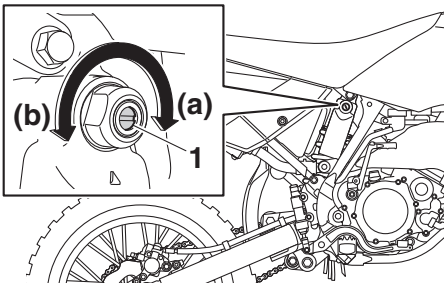

1. Compression damping force adjusting screw

WARNING

This shock absorber assembly contains highly pressurized nitrogen gas. Read and understand the following information before handling the shock absorber assembly.

- Do not tamper with or attempt to open the cylinder assembly.
- Do not subject the shock absorber assembly to an open flame or other high heat source. This may cause the unit to explode due to excessive gas pressure.
- Do not deform or damage the cylinder in any way. Cylinder damage will result in poor damping performance.

Instrument and control functions

EAU41382

- Do not dispose of a damaged or worn-out shock absorber assembly yourself. Take the shock absorber assembly to a Yamaha dealer for any service.

Removable sidestand

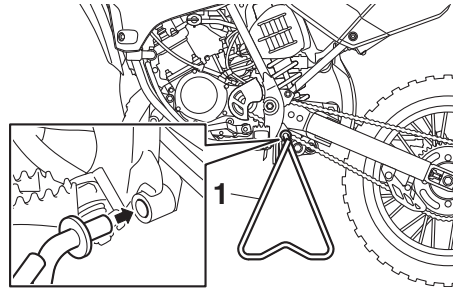

1. Sidestand

This motorcycle is equipped with a removable sidestand.

TIP

Make sure that the sidestand is properly secured when the motorcycle is being supported or is being transported.

EWA14602

! WARNING

- Never apply force on the motorcycle while it is on the sidestand.
- Always remove the sidestand before starting out.

Instrument and control functions

EAU84180

YPVS system

This model's engine is fitted with Yamaha Power Valve System (YPVS). This system boosts engine power by means of a valve that controls exhaust port opening aperture.

ECA26380

NOTICE

The YPVS system has been extensively tested and set-up by Yamaha. Changing the YPVS settings without sufficient technical knowledge can result in reduced engine performance or even engine damage.

For your safety – pre-operation checks

EAU63441

Inspect your vehicle each time you use it to make sure the vehicle is in safe operating condition. Always follow the inspection and maintenance procedures and schedules described in the Owner's Manual.

EWA11152

WARNING

Failure to inspect or maintain the vehicle properly increases the possibility of an accident or equipment damage. Do not operate the vehicle if you find any problem. If a problem cannot be corrected by the procedures provided in this manual, have the vehicle inspected by a Yamaha dealer.

Before using this vehicle, check the following points:

ITEM	CHECKS	PAGE
Fuel	<ul style="list-style-type: none">• Check fuel level in fuel tank.• Always use a fresh mixture of gasoline and oil.• Check fuel line for leakage.• Check fuel tank breather hose for obstructions, cracks or damage, and check hose connection.	4-4, 4-6
Transmission oil	<ul style="list-style-type: none">• Check for leakage.	7-7
Coolant	<ul style="list-style-type: none">• Check coolant level.• If necessary, add recommended coolant to specified level.• Check cooling system for leakage.	7-8
Front brake	<ul style="list-style-type: none">• Check operation.• If soft or spongy, have Yamaha dealer bleed hydraulic system.• Check brake pads for wear.• Replace if necessary.• Check fluid level in reservoir.• If necessary, add specified brake fluid to specified level.• Check hydraulic system for leakage.	7-19, 7-20
Rear brake	<ul style="list-style-type: none">• Check operation.• If soft or spongy, have Yamaha dealer bleed hydraulic system.• Check brake pads for wear.• Replace if necessary.• Check fluid level in reservoir.• If necessary, add specified brake fluid to specified level.• Check hydraulic system for leakage.	7-19, 7-20
Clutch	<ul style="list-style-type: none">• Check operation.• Lubricate cable if necessary.• Check lever free play.• Adjust if necessary.	7-17
Throttle grip	<ul style="list-style-type: none">• Make sure that operation is smooth.• Check throttle grip free play.• If necessary, adjust throttle grip free play.	7-13, 7-24

For your safety – pre-operation checks

ITEM	CHECKS	PAGE
Drive chain	<ul style="list-style-type: none"> • Check chain slack. • Adjust if necessary. • Check chain condition. • Lubricate if necessary. 	7-21, 7-23
Drive sprocket	<ul style="list-style-type: none"> • Check the drive sprocket nut torque. • Tighten if necessary. 	—
Wheels and tires	<ul style="list-style-type: none"> • Check for damage. • Check tire condition and tread depth. • Check air pressure. • Correct if necessary. • Check for loose spokes and tighten if necessary. 	7-14, 7-16
Shift pedal	<ul style="list-style-type: none"> • Make sure that operation is smooth. • Check the shift pedal bolt torque. • Correct if necessary. 	7-18
Brake pedal	<ul style="list-style-type: none"> • Make sure that operation is smooth. • Lubricate pedal pivoting point if necessary. 	7-25
Brake and clutch levers	<ul style="list-style-type: none"> • Make sure that operation is smooth. • Lubricate lever pivoting points if necessary. 	7-24
Steering	<ul style="list-style-type: none"> • Check that the handlebar can be turned smoothly and has no excessive play. 	7-27
Front fork and rear shock absorber assembly	<ul style="list-style-type: none"> • Check that they operate smoothly and there is no oil leakage. 	4-9, 4-11, 4-12, 7-26
Chassis fasteners	<ul style="list-style-type: none"> • Make sure that all nuts, bolts and screws are properly tightened. • Check all cotter pins for damage and correct installation. • Tighten or replace if necessary. 	—
Moving parts and cables	<ul style="list-style-type: none"> • Check the control cables for damage. • Check that the control cables move smoothly. • Check that the control cables are not caught when the handlebars are turned or when the front forks travel up and down. • Lubricate moving parts and cables if necessary. 	7-23, 7-24, 7-26, 7-25
Exhaust system	<ul style="list-style-type: none"> • Check that the exhaust pipe and muffler are tightly mounted and have no cracks. • Check for leakage. 	—
Engine stop switch	<ul style="list-style-type: none"> • Check operation. 	4-1
Ignition system	<ul style="list-style-type: none"> • Check that all leads and cables are properly connected. 	7-6

Operation and important riding points

EAU15952

EAU41506

Read the Owner's Manual carefully to become familiar with all controls. If there is a control or function you do not understand, ask your Yamaha dealer.

EWA10322

WARNING

Failure to familiarize yourself with the controls can lead to loss of control, which could cause an accident or injury.

EWA10272

Engine break-in

WARNING

Failure to properly maintain the vehicle or performing maintenance activities incorrectly may increase your risk of injury or death during service or while using the vehicle. If you are not familiar with vehicle service, have a Yamaha dealer perform service.

TIP

Before starting the engine for the first time, the air filter must be lubricated. (See page 7-10.)

Engine break-in procedure

1. Fill the fuel tank with a break-in oil-fuel mixture as follows.

Recommended 2-stroke engine oil:
YAMALUBE 2R
Mixing ratio (gasoline to oil):
15:1

2. Start and warm up the engine. Check the operation of the controls and the engine stop switch. (See page 4-1.)
3. Operate the motorcycle in the lower gears at moderate throttle openings for 5 to 8 minutes. Stop the engine and check the spark plug condition (see page 7-6); it will show a rich condition during break-in.
4. Allow the engine to cool. Restart the engine and operate the motorcycle as in the step above for 5 minutes. Then, very briefly shift to

Operation and important riding points

the higher gears and check the full-throttle response. Stop the engine and check the spark plug.

5. After again allowing the engine to cool, restart and run the motorcycle for 5 more minutes. Full throttle and the higher gears may be used, but sustained full-throttle operation should be avoided. Stop the engine and check the spark plug again.
6. Allow the engine to cool, remove the cylinder head and cylinder, and inspect the piston and cylinder. Remove any high spots on the piston with #600-grit wet sandpaper. Clean all components and carefully reassemble the cylinder head and cylinder.
7. Drain the break-in oil-fuel mixture from the fuel tank and refill with the normal oil-fuel mixture. (See page 4-4.)
8. Start the engine and check its power delivery and throttle response throughout all gear ranges. Stop the engine and check the spark plug condition. It should begin to lighten in color.
9. Restart the motorcycle and ride it for about 10 to 15 more minutes. Stop the engine and check the spark plug condition. (See page 7-6.)
10. Lastly, thoroughly check the motorcycle for loose parts, oil leakage and any other problems. Check all fittings and fasteners and tighten as necessary.

TIP

Be sure to inspect and make adjustments thoroughly. In particular, check control cable slack, drive chain slack and for loose spokes.

Notes on engine overhauls

If the following parts have been replaced, they must be broken in as follows.

- Piston, rings or transmission gears: 30 minutes of break-in operation at half-throttle or less.
- Cylinder or crankshaft: 60 minutes of break-in operation is necessary.

TIP

Observe the condition of the engine carefully during break-in operation.

ECA10271

NOTICE

If any engine trouble should occur during the engine break-in period, immediately have a Yamaha dealer check the vehicle.

Operation and important riding points

EAU41308

EAU16661

Starting and warming up a cold engine

1. Turn the fuel cock lever to "ON".
2. Shift the transmission into the neutral position.
3. Turn the starter (choke) on and completely close the throttle. (See page 4-7.)
4. Start the engine by pushing the kickstarter lever down.
5. When the engine is warm, turn the starter (choke) off.

TIP

The engine is warm when it responds quickly to the throttle with the starter (choke) turned off.

ECA11043

NOTICE

For maximum engine life, never accelerate hard when the engine is cold!

Starting a warm engine

Follow the same procedure as for starting a cold engine with the exception that the starter (choke) is not required when the engine is warm. Instead, start the engine with the throttle slightly open.

TIP

If the engine does not start after several kicks, try again with the throttle 1/4 to 1/2 open.

Operation and important riding points

Shifting

EAU16674

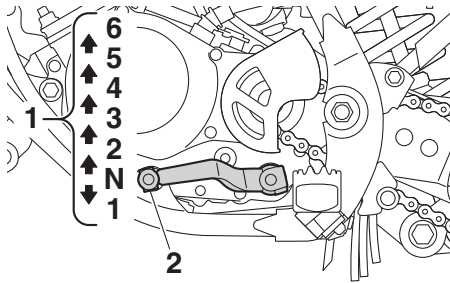

1. Gear positions
2. Shift pedal

Shifting gears lets you control the amount of engine power available for starting off, accelerating, climbing hills, etc.

The gear positions are shown in the illustration.

TIP

To shift the transmission into the neutral position (N), press the shift pedal down repeatedly until it reaches the end of its travel, and then slightly raise it.

ECA10261

NOTICE

- **Even with the transmission in the neutral position, do not coast for long periods of time with the engine off, and do not tow the motorcycle for long distances. The transmission is properly lubricated only when the engine is running. Inadequate lubrication may damage the transmission.**
- **Always use the clutch while changing gears to avoid damaging the engine, transmission,**

and drive train, which are not designed to withstand the shock of forced shifting.

EAU16691

To start out and accelerate

1. Pull the clutch lever to disengage the clutch.
2. Shift the transmission into first gear.
3. Open the throttle gradually and simultaneously release the clutch lever slowly.
4. Once the motorcycle has reached a speed high enough to change gears, close the throttle, and at the same time, quickly pull the clutch lever in.
5. Shift the transmission into second gear. (Make sure not to shift the transmission into the neutral position.)
6. Open the throttle halfway and gradually release the clutch lever.
7. Follow the same procedure when shifting to the next gear.

EAU16711

To decelerate

1. Close the throttle and apply both the front and the rear brakes to slow the motorcycle.
2. Downshift through the gears and shift the transmission into the neutral position when the motorcycle is almost completely stopped.

Operation and important riding points

EAU17192

Parking

When parking, stop the engine, and then turn the fuel cock lever to “OFF”.

EWA10312

WARNING

- Since the engine and exhaust system can become very hot, park in a place where pedestrians or children are not likely to touch them and be burned.
 - Do not park on a slope or on soft ground, otherwise the vehicle may overturn, increasing the risk of a fuel leak and fire.
 - Do not park near grass or other flammable materials which might catch fire.
-

Periodic maintenance and adjustment

EAU42074

Periodic inspection, adjustment, and lubrication will keep your vehicle in the safest and most efficient condition possible. Safety is an obligation of the vehicle owner/operator. The most important points of vehicle inspection, adjustment, and lubrication are explained on the following pages.

The intervals given in the periodic maintenance and lubrication chart should be simply considered as a general guide under normal riding conditions. However, depending on the weather, terrain, geographical location, and individual use, the maintenance intervals may need to be shortened.

EWA10322

WARNING

Failure to properly maintain the vehicle or performing maintenance activities incorrectly may increase your risk of injury or death during service or while using the vehicle. If you are not familiar with vehicle service, have a Yamaha dealer perform service.

EWA15123

WARNING

Turn off the engine when performing maintenance unless otherwise specified.

- **A running engine has moving parts that can catch on body parts or clothing and electrical parts that can cause shocks or fires.**
- **Running the engine while servicing can lead to eye injury, burns, fire, or carbon monoxide poisoning – possibly leading to**

death. See page 2-2 for more information about carbon monoxide.

EWA15461

WARNING

Brake discs, calipers, drums, and linings can become very hot during use. To avoid possible burns, let brake components cool before touching them.

Periodic maintenance and adjustment

EAU66354

Periodic maintenance and lubrication chart

The following chart is intended as a general guide to maintenance and lubrication. Bear in mind that such factors as weather, terrain, geographical location, and individual usage will alter the required maintenance and lubrication intervals. If you are in doubt as to what intervals to follow in maintaining and lubricating your motorcycle, consult your Yamaha dealer.

TIP

Items marked with an asterisk should be performed by a Yamaha dealer as they require special tools, data and technical skills.

NO.	ITEM	ROUTINE	After break-in	Every race	Every third race	Every fifth race	As required
1	* Piston	• Check piston for carbon deposits and cracks or damage.	√	√			
		• Clean. • Replace.				√	√
2	* Piston rings	• Check piston ring end gap and rings for damage.	√	√			
		• Replace.			√		√
3	* Piston pin and small end bearing	• Check piston pin and small end bearing for damage.		√			
		• Replace.					√
4	* Cylinder head	• Check cylinder head for carbon deposits.	√	√			
		• Clean.					
		• Check cylinder head gasket for damage. • Tighten cylinder head nuts if necessary.	√	√			
		• Replace cylinder head gasket.					√
5	* Cylinder	• Check cylinder for score marks or wear.	√	√			
		• Clean.					
		• Replace.					√
6	* YPVS	• Check YPVS for carbon deposits and cracks or damage.	√	√			
		• Clean.	√	√			

Periodic maintenance and adjustment

NO.	ITEM	ROUTINE	After break-in	Every race	Every third race	Every fifth race	As required
7	* Clutch	• Check clutch housing, friction plates, clutch plates and clutch springs for wear or damage.	√	√			
		• Adjust. • Replace.					√
8	* Transmission	• Change the transmission oil.	√			√	
		• Check transmission for damage.					√
		• Replace bearings.					√
9	* Shift forks, guide bars, shift cam	• Check all parts for wear and damage. • Replace if necessary.					√
10	* Rotor nut (flywheel magneto)	• Tighten.	√			√	
11	* Kickstarter system	• Check idle gear for damage. • Replace if necessary.					√
12	* Exhaust system	• Check exhaust pipe and muffler for carbon deposits.	√	√			
		• Clean.				√	
13	* Crankshaft	• Check crankshaft for carbon deposits and damage.				√	√
		• Clean.				√	√
14	* Carburetor	• Check carburetor settings and for obstructions.	√	√			
		• Adjust and clean.	√	√			
15	* Spark plug	• Check condition. • Clean and regap.	√	√			
		• Replace.					√
16	* Drive chain	• Check chain slack, alignment and condition.	√	√			
		• Adjust and thoroughly lubricate chain with Yamaha chain and cable lube or equivalent. • Replace.					√

Periodic maintenance and adjustment

NO.	ITEM	ROUTINE	After break-in	Every race	Every third race	Every fifth race	As required
17 *	Cooling system	• Check coolant level and for leakage.	√	√			
		• Check hoses for cracks or damage.		√			
		• Check radiator cap spring operation.					√
		• Change coolant.	Every 2 years				√
18 *	Chassis fasteners	• Check all chassis fitting and fasteners.	√	√			
		• Correct or tighten if necessary.					
19	Air filter element	• Clean.	√	√			
		• Replace.					√
20 *	Frame	• Clean and check for damage.	√	√			
21 *	Fuel line	• Clean and check for leakage.	√		√		
22 *	Brakes	• Adjust lever position and pedal height.					
		• Lubricate pivot points.					
		• Check brake disk surface.	√	√			
		• Check fluid level and for leakage.					
		• Tighten brake disk bolts, caliper bolts, master cylinder bolts and union bolts.					
		• Replace brake pads.					√
		• Replace brake fluid.	Every year				√
23 *	Front fork	• Check operation and for oil leakage.	√	√			
		• Adjust if necessary.					
		• Clean dust seal and lubricate with lithium-soap-based grease.					
		• Replace fork oil.	√			√	
		• Replace oil seals.					√

Periodic maintenance and adjustment

NO.	ITEM	ROUTINE	After break-in	Every race	Every third race	Every fifth race	As required
24	* Shock absorber assembly	• Check operation and adjust. • Tighten if necessary.	√	√			
		• Lubricate with lithium-soap-based grease.			√		√ *
25	* Drive chain roller and support guide	• Check for wear or damage. • Replace if necessary.					√
26	* Rear suspension	• Check operation and tighten if necessary.	√	√			
		• Lubricate with molybdenum disulfide grease.	√	√			
27	* Swingarm pivot bearings	• Check bearing assemblies for looseness. • Lubricate with molybdenum disulfide grease.	√	√			
28	* Steering head	• Check operation, free play, and tighten if necessary.	√	√			
		• Clean and lubricate with lithium-soap-based grease.				√	
		• Replace bearings.					√
29	* Tires and wheels	• Check tire air pressure, wheel runout, spokes for looseness, and tires for wear.	√	√			
		• Tighten sprocket bolts if necessary.	√	√			
		• Check wheel bearings for looseness.			√		
		• Lubricate wheel bearings with lithium-soap-based grease.			√		
		• Replace wheel bearings.					√
30	* Moving parts and cables	• Lubricate.	√	√			
31	* Throttle grip	• Check operation. • Check throttle grip free play, and adjust if necessary. • Lubricate cable and grip housing.	√	√			

* After washing the motorcycle or riding in the rain.

EAU42012

TIP

- Hydraulic brake service
 - Regularly check and, if necessary, correct the brake fluid levels.
 - Every two years replace the internal components of the brake master cylinders and calipers, and change the brake fluid.
 - Replace the brake hoses every four years and if cracked or damaged.

Periodic maintenance and adjustment

EAU84450

Checking the spark plug

The spark plug is an important engine component, which is easy to check. Since heat and deposits will cause any spark plug to slowly erode, the spark plug should be removed and checked in accordance with the periodic maintenance and lubrication chart. In addition, the condition of the spark plug can reveal the condition of the engine.

To remove the spark plug

1. Remove the spark plug cap.

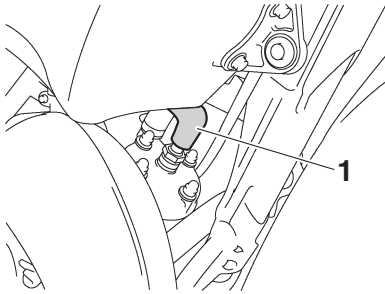

1. Spark plug cap

2. Remove the spark plug as shown, with a spark plug wrench available at a Yamaha dealer.

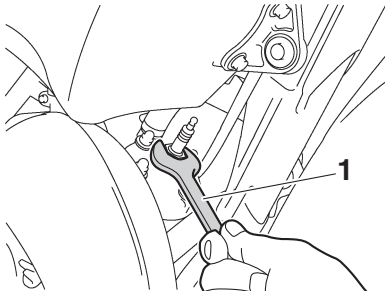

1. Spark plug wrench

To check the spark plug

1. Check that the porcelain insulator around the center electrode of the spark plug is a medium-to-light tan (the ideal color when the vehicle is ridden normally).

TIP

If the spark plug shows a distinctly different color, the engine could be operating improperly. Do not attempt to diagnose such problems yourself. Instead, have a Yamaha dealer check the vehicle.

2. Check the spark plug for electrode erosion and excessive carbon or other deposits, and replace it if necessary.

Specified spark plug:

NGK/BR10EG

3. Measure the spark plug gap with a wire thickness gauge and, if necessary, adjust the gap to specification.

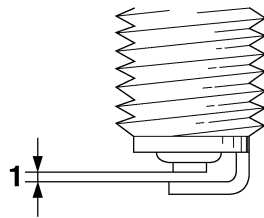

1. Spark plug gap

Spark plug gap:

0.5–0.6 mm (0.020–0.024 in)

Periodic maintenance and adjustment

EAU4144C

To install the spark plug

1. Clean the surface of the spark plug gasket and its mating surface, and then wipe off any grime from the spark plug threads.
2. Install the spark plug with the spark plug wrench, and then tighten it to the specified torque.

Tightening torque:

Spark plug:
20 N·m (2.0 kgf·m, 15 lb·ft)

TIP

If a torque wrench is not available when installing a spark plug, a good estimate of the correct torque is 1/4–1/2 turn past finger tight. However, the spark plug should be tightened to the specified torque as soon as possible.

3. Install the spark plug cap as shown.

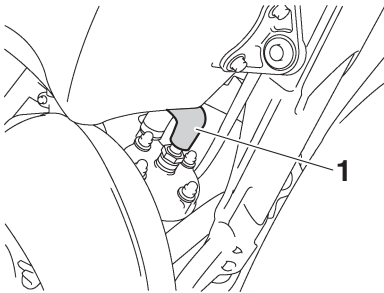

1. Spark plug cap

Transmission oil

The transmission must be checked for oil leakage before each ride. If any leakage is found, have a Yamaha dealer check and repair the motorcycle. In addition, the transmission oil must be changed at the intervals specified in the periodic maintenance and lubrication chart.

1. Start the engine, warm it up for several minutes, and then turn it off.
2. Place the motorcycle on a level surface and hold it in an upright position.
3. Place an oil pan under the transmission case to collect the used oil.
4. Remove the transmission oil filler cap and its O-ring, and then remove the transmission oil drain bolt and its gasket to drain the oil from the transmission.

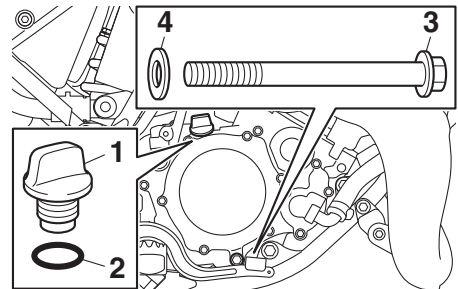

1. Transmission oil filler cap
2. O-ring
3. Transmission oil drain bolt
4. Gasket

5. Install the drain bolt and its new gasket, and then tighten the bolt to the specified torque.

Periodic maintenance and adjustment

EAU20071

Tightening torque:

Transmission oil drain bolt:
10 N·m (1.0 kgf·m, 7.4 lb·ft)

6. Refill with the specified amount of the recommended transmission oil.

Recommended transmission oil:

Motor oil SAE 10W-30 type SE or higher or Gear oil SAE 85W GL-3

Oil change quantity:

0.50 L (0.53 US qt, 0.44 Imp.qt)

ECA10453

NOTICE

- In order to prevent clutch slippage (since the transmission oil also lubricates the clutch), do not mix any chemical additives. Do not use oils with a diesel specification of "CD" or oils of a higher quality than specified. In addition, do not use oils labeled "ENERGY CONSERVING II" or higher.
- Make sure that no foreign material enters the transmission.

7. Check the O-ring for damage, and replace it if necessary.
8. Install and tighten the transmission oil filler cap and its O-ring.
9. Start the engine, and then let it idle for several minutes while checking it for oil leakage. If oil is leaking, immediately turn the engine off and check for the cause.

Coolant

The coolant level should be checked before each ride. In addition, the coolant must be changed at the intervals specified in the periodic maintenance and lubrication chart.

EAM1296

To check the coolant level

1. Place the vehicle on a level surface and hold it in an upright position.

TIP

- The coolant level must be checked on a cold engine since the level varies with engine temperature.
- Make sure that the vehicle is positioned straight up when checking the coolant level. A slight tilt to the side can result in a false reading.

2. Remove the radiator cap and check the coolant level in the radiator. **WARNING! Never attempt to remove the radiator cap when the engine is hot.** [EWA10382]

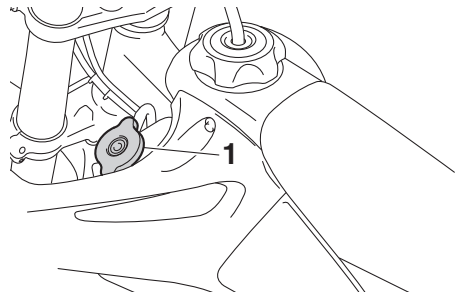

1. Radiator cap

Periodic maintenance and adjustment

TIP

The coolant should be at the bottom of the radiator filler neck. The level will change with variation of engine temperature.

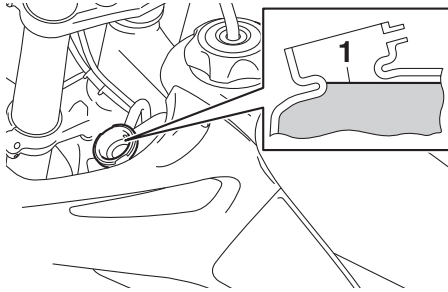

1. Correct coolant level

3. If the coolant is below the correct coolant level, add coolant, and then install the radiator cap. **NOTICE:** If coolant is not available, use distilled water or soft tap water instead. Do not use hard water or salt water since it is harmful to the engine. If water has been used instead of coolant, replace it with coolant as soon as possible, otherwise the cooling system will not be protected against frost and corrosion. If water has been added to the coolant, have a Yamaha dealer check the antifreeze content of the coolant as soon as possible, otherwise the effectiveness of the coolant will be reduced. [ECA10473]

To change the coolant

EAUM1318

1. Place the vehicle on a level surface and let the engine cool if necessary.

2. Place a container under the engine to collect the used coolant.
3. Remove the radiator cap, and then the coolant drain bolt and its gasket to drain the cooling system. **WARNING! Never attempt to remove the radiator cap when the engine is hot.** [EWA10382]

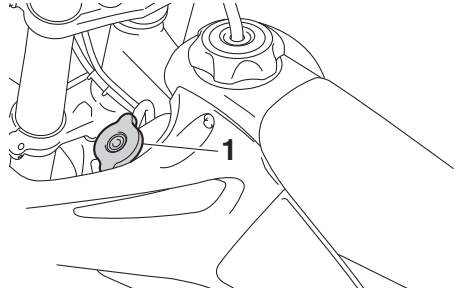

1. Radiator cap

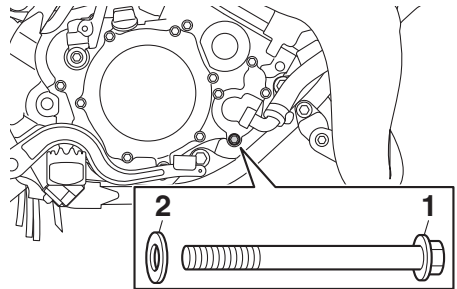

1. Coolant drain bolt
2. Gasket

4. After the coolant is completely drained, thoroughly flush the cooling system with clean tap water.
5. Install the coolant drain bolt and its new gasket, and then tighten the bolt to the specified torque.

Tightening torque:

Coolant drain bolt:
10 N·m (1.0 kgf·m, 7.4 lb·ft)

Periodic maintenance and adjustment

EAU48393

6. Pour the recommended coolant into the radiator until it is full.

Antifreeze/water mixture ratio:

1:1

Recommended antifreeze:

High-quality ethylene glycol antifreeze containing corrosion inhibitors for aluminum engines

Coolant quantity:

Radiator (including all routes):
0.55 L (0.58 US qt, 0.48 Imp.qt)

7. Install the radiator cap, start the engine, let it idle for several minutes, and then turn it off.
8. Remove the radiator cap to check the coolant level in the radiator. If necessary, add sufficient coolant until it reaches the bottom of the radiator filler neck, and then install the radiator cap.
9. Start the engine, and then check the vehicle for coolant leakage. If coolant is leaking, have a Yamaha dealer check the cooling system.

Cleaning the air filter element

The air filter element should be cleaned or replaced at the intervals specified in the periodic maintenance and lubrication chart. Clean or, if necessary, replace the air filter element more frequently if you are riding in unusually wet or dusty areas.

1. Remove the seat. (See page 4-8.)
2. Remove the air filter case cover as shown.

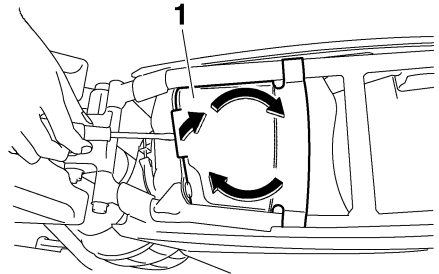

1. Air filter case cover

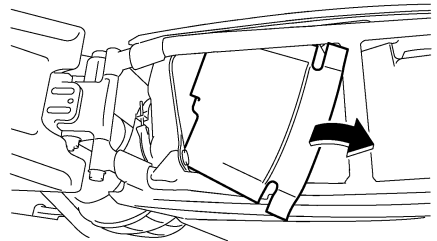

3. Remove the air filter element by removing the wing bolt and its washer.

Periodic maintenance and adjustment

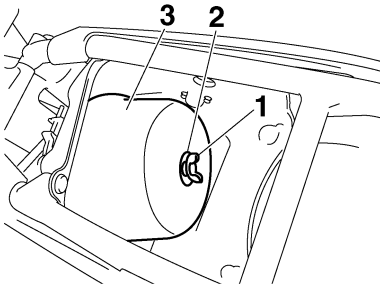

1. Wing bolt
 2. Washer
 3. Air filter element
4. Remove the sponge material from the air filter element frame.

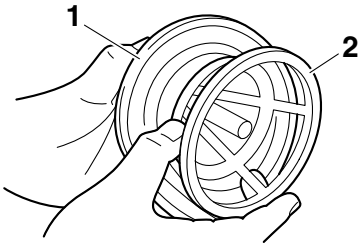

1. Sponge material
 2. Air filter element frame
5. Clean the sponge material with solvent, and then squeeze the remaining solvent out.

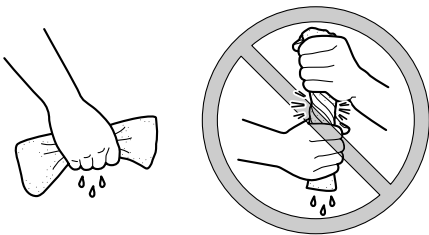

6. Apply oil of the recommended type to the entire surface of the sponge material, and then squeeze the excess oil out.

TIP

The sponge material should be wet but not dripping.

Recommended oil:

Yamaha foam air filter oil or other quality foam air filter oil

7. Pull the sponge material over the air filter element frame.
 8. Insert the air filter element into the air filter case with the projection facing upward, and then install the wing bolt and its washer.
- NOTICE:** Make sure that the air filter element is properly seated in the air filter case. The engine should never be operated without the air filter element installed, otherwise the piston(s) and/or cylinder(s) may become excessively worn. [ECA10482]
- NOTICE:** Be sure to install the washer with its curved side facing outward as shown. [ECA16692]

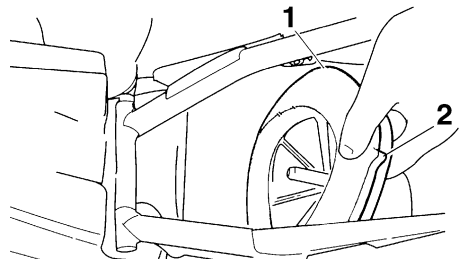

1. Air filter element
2. Projection

Periodic maintenance and adjustment

EAU42111

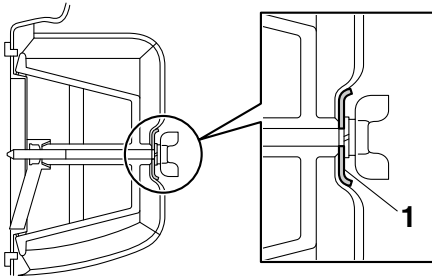

1. Washer

9. Install the air filter case cover in the original position as shown.

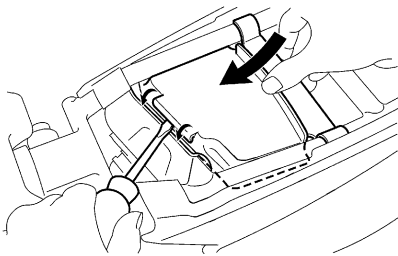

10. Install the seat.

Adjusting the carburetor

The carburetor is an important part of the engine and requires very sophisticated adjustment. Therefore, most carburetor adjustments should be left to a Yamaha dealer, who has the necessary professional knowledge and experience. The adjustment described in the following section, however, may be serviced by the owner as part of routine maintenance.

ECA10551

NOTICE

The carburetor has been set and extensively tested at the Yamaha factory. Changing these settings without sufficient technical knowledge may result in poor performance of or damage to the engine.

Periodic maintenance and adjustment

EAU44391

EAU48434

Adjusting the engine idling speed

The engine idling speed must be adjusted when necessary.

1. Start the engine and thoroughly warm it up.
2. Turn the throttle stop screw until the engine runs at the lowest possible speed.
3. To increase the engine idling speed, turn the throttle stop screw in direction (a). To decrease the engine idling speed, turn the throttle stop screw in direction (b).

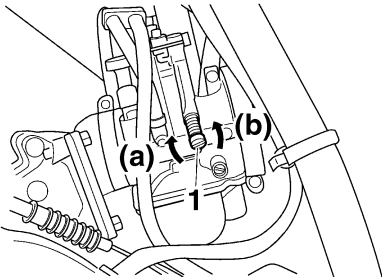

1. Throttle stop screw

Adjusting the throttle grip free play

Measure the throttle grip free play as shown.

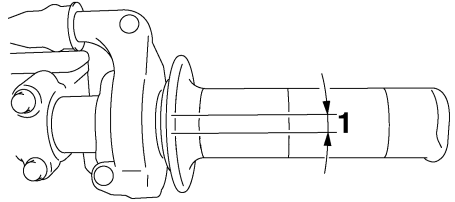

1. Throttle grip free play

Throttle grip free play:

3.0–6.0 mm (0.12–0.24 in)

Periodically check the throttle grip free play and, if necessary, adjust it as follows.

TIP

The engine idling speed must be correctly adjusted before checking and adjusting the throttle grip free play.

1. Slide the rubber cover back.
2. Loosen the locknut.
3. To increase the throttle grip free play, turn the adjusting nut in direction (a). To decrease the throttle grip free play, turn the adjusting nut in direction (b).

Periodic maintenance and adjustment

EAU65042

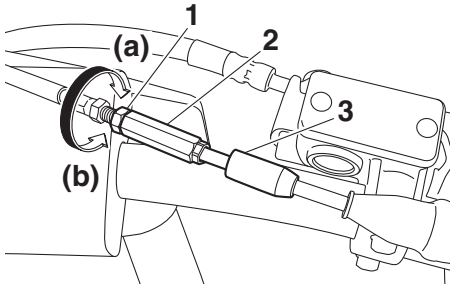

1. Locknut
2. Throttle grip free play adjusting nut
3. Rubber cover
4. Tighten the locknut and then slide the rubber cover to its original position.

Tires

Tires are the only contact between the vehicle and the road. Safety in all conditions of riding depends on a relatively small area of road contact. Therefore, it is essential to maintain the tires in good condition at all times and replace them at the appropriate time with the specified tires.

Tire air pressure

The tire air pressure should be checked and, if necessary, adjusted before each ride.

EWA14382

WARNING

Operation of this vehicle with improper tire pressure may cause severe injury or death from loss of control.

- The tire air pressure must be checked and adjusted on cold tires (i.e., when the temperature of the tires equals the ambient temperature).
- The tire air pressure must be adjusted in accordance with the weight of the rider, the riding speed, and the riding conditions.

Standard tire air pressure:

Front:

100 kPa (1.00 kgf/cm², 15 psi)

Rear:

100 kPa (1.00 kgf/cm², 15 psi)

Periodic maintenance and adjustment

Tire inspection

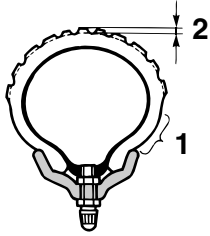

1. Tire sidewall
2. Tire tread depth

The tires must be checked before each ride.

ECA15582

NOTICE

- **Make sure the bead stopper is tightened. A loose bead stopper will cause the tire to slip off the rim if tire pressure is too low.**
- **Make sure the valve stem is positioned straight. A tilted valve stem indicates that the tire has slipped from its original position on the rim. Rotate the tire so that the valve stem is positioned straight.**

If the center tread depth reaches the specified limit, if the tire has a nail or glass fragments in it, or if the sidewall is cracked, have a Yamaha dealer replace the tire immediately.

Minimum tire tread depth (front and rear):
4.0 mm (0.16 in)

Tire information

This model is equipped with tube tires.

Tires age, even if they have not been used or have only been used occasionally. Cracking of the tread and sidewall rubber, sometimes accompanied by carcass deformation, is an evidence of ageing. Old and aged tires shall be checked by tire specialists to ascertain their suitability for further use.

EWA10462

WARNING

The front and rear tires should be of the same make and design, otherwise the handling characteristics of the vehicle may be different, which could lead to an accident.

After extensive tests, only the tires listed below have been approved for this model by Yamaha.

Front tire:

Size:
70/100-17 40M
Manufacturer/model:
DUNLOP/MX3SF

Rear tire:

Size:
90/100-14 49M
Manufacturer/model:
DUNLOP/MX3S

EWA14391

WARNING

- **Have a Yamaha dealer replace excessively worn tires. Operating the motorcycle with excessively worn tires decreases riding stability and can lead to loss of control.**
- **The replacement of all wheel- and brake-related parts, including the tires, should be left to a Yamaha dealer, who has the necessary professional knowledge and experience.**

Periodic maintenance and adjustment

- It is not recommended to patch a punctured tube. If unavoidable, however, patch the tube very carefully and replace it as soon as possible with a high-quality product.
-

EAU48322

Spoke wheels

EWA10611

WARNING

The wheels on this model are not designed for use with tubeless tires. Do not attempt to use tubeless tires on this model.

To maximize the performance, durability, and safe operation of your motorcycle, note the following points regarding the specified wheels.

- The wheel rims should be checked for cracks, bends, warpage or other damage and the spokes for looseness or damage before each ride. If any damage is found, have a Yamaha dealer replace the wheel. Do not attempt even the smallest repair to the wheel. A deformed or cracked wheel must be replaced.
- The wheel should be balanced whenever either the tire or wheel has been changed or replaced. An unbalanced wheel can result in poor performance, adverse handling characteristics, and a shortened tire life.

Periodic maintenance and adjustment

EAU65775

Adjusting the clutch lever free play

Measure the clutch lever free play as shown.

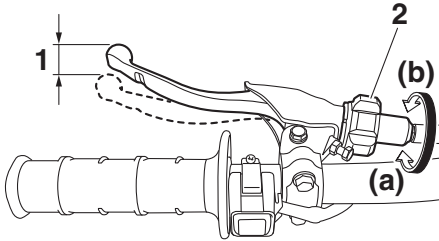

1. Clutch lever free play
2. Clutch lever free play adjuster

Clutch lever free play:
7.0–12.0 mm (0.28–0.47 in)

Periodically check the clutch lever free play and, if necessary, adjust it.

To increase the clutch lever free play, turn the clutch lever free play adjuster in direction (a). To decrease the clutch lever free play, turn the adjuster in direction (b).

TIP

If the specified clutch lever free play cannot be obtained as described above, proceed as follows.

1. Fully turn the adjuster in direction (a) to loosen the clutch cable.
2. Slide the rubber cover and clutch lever free play adjuster back further down the clutch cable, and then loosen the locknut.
3. To increase the clutch lever free play, turn the clutch lever free play adjusting bolt in direction (a). To

decrease the clutch lever free play, turn the adjusting bolt in direction (b).

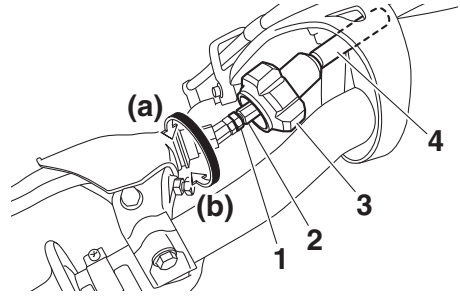

1. Locknut
2. Clutch lever free play adjusting bolt
3. Clutch lever free play adjuster
4. Rubber cover

4. Tighten the locknut at the clutch cable.
5. Slide the clutch lever free play adjuster and rubber cover to their original positions, making sure to align the slot in the adjuster with the slot in the adjusting bolt.

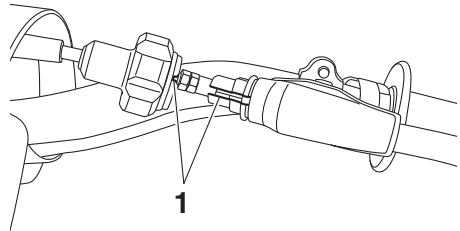

1. Slot

Periodic maintenance and adjustment

Checking the brake lever free play

EAU37914

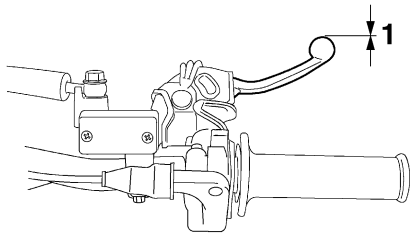

1. No brake lever free play

There should be no free play at the brake lever end. If there is free play, have a Yamaha dealer inspect the brake system.

EWA14212

WARNING

A soft or spongy feeling in the brake lever can indicate the presence of air in the hydraulic system. If there is air in the hydraulic system, have a Yamaha dealer bleed the system before operating the vehicle. Air in the hydraulic system will diminish the braking performance, which may result in loss of control and an accident.

Checking the shift pedal

EAU44821

The operation of the shift pedal should be checked before each ride. If operation is not smooth, have a Yamaha dealer check the vehicle.

Periodic maintenance and adjustment

Checking the front and rear brake pads

EAU22393

The front and rear brake pads must be checked for wear at the intervals specified in the periodic maintenance and lubrication chart.

Front brake pads

EAU22411

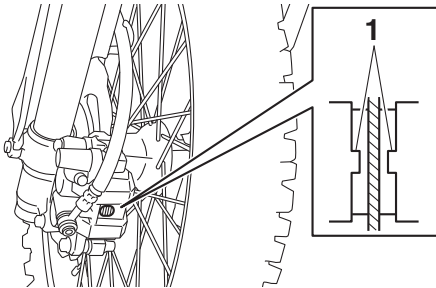

1. Brake pad wear indicator

Each front brake pad is provided with a wear indicator, which allows you to check the brake pad wear without having to disassemble the brake. To check the brake pad wear, check the position of the wear indicator while applying the brake. If a brake pad has worn to the point that the wear indicator almost touches the brake disc, have a Yamaha dealer replace the brake pads as a set.

Rear brake pads

EAU46292

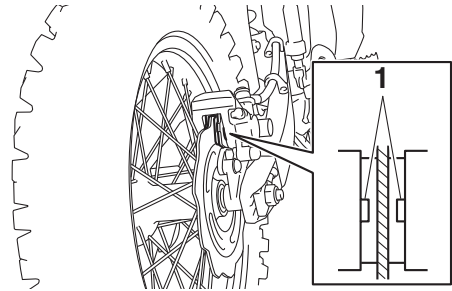

1. Brake pad wear indicator groove

Each rear brake pad is provided with wear indicator grooves, which allow you to check the brake pad wear without having to disassemble the brake. To check the brake pad wear, check the wear indicator grooves. If a brake pad has worn to the point that a wear indicator groove almost appears, have a Yamaha dealer replace the brake pads as a set.

Periodic maintenance and adjustment

EAU22583

Checking the brake fluid level

Before riding, check that the brake fluid is above the minimum level mark. Check the brake fluid level with the reservoir in an upright position. Replenish the brake fluid if necessary.

Specified brake fluid:
DOT 4

ECA17641

NOTICE

Brake fluid may damage painted surfaces or plastic parts. Always clean up spilled fluid immediately.

Front brake

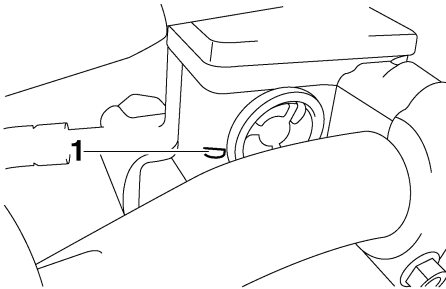

1. Minimum level mark

Rear brake

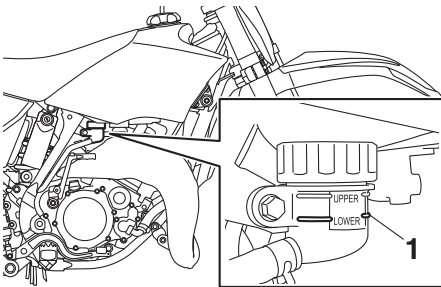

1. Minimum level mark

As the brake pads wear, it is normal for the brake fluid level to gradually go down.

- A low brake fluid level may indicate worn brake pads or brake system leakage; therefore, be sure to check the brake pads for wear and the brake system for leakage.
- If the brake fluid level goes down suddenly, have a Yamaha dealer check the cause before further riding.

EWA15991

WARNING

Improper maintenance can result in loss of braking ability. Observe these precautions:

- Insufficient brake fluid may allow air to enter the brake system, reducing braking performance.
- Clean the filler cap before removing. Use only DOT 4 brake fluid from a sealed container.
- Use only the specified brake fluid; otherwise, the rubber seals may deteriorate, causing leakage.
- Refill with the same type of brake fluid. Adding a brake fluid other than DOT 4 may result in a harmful chemical reaction.
- Be careful that water does not enter the brake fluid reservoir when refilling. Water will significantly lower the boiling point of the fluid and may result in vapor lock.

Periodic maintenance and adjustment

Changing the brake fluid

EAU51721

Have a Yamaha dealer change the brake fluid at the intervals specified in the periodic maintenance and lubrication chart. In addition, have the oil seals of the master cylinders and calipers as well as the brake hoses replaced at the intervals listed below or whenever they are damaged or leaking.

- Oil seals: Replace every two years.
- Brake hoses: Replace every four years.

Drive chain slack

EAU22762

The drive chain slack should be checked before each ride and adjusted if necessary.

To check the drive chain slack

EAU84400

1. Place the motorcycle on a suitable stand. (See page 7-28.)
2. Confirm the rear wheel is off the ground and the rear shock absorber is fully extended.
3. Shift the transmission into neutral.
4. Pull up the drive chain until the chain is taut, and then measure distance A between the top of the swingarm and the bottom of the chain as shown.

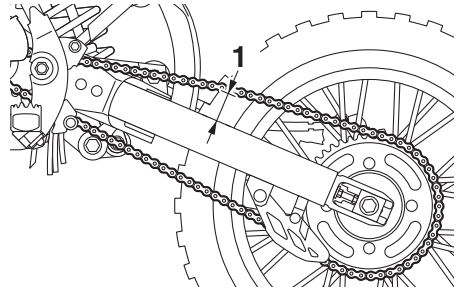

1. Distance A

Distance A:

58.0–68.0 mm (2.28–2.68 in)

5. If the drive chain slack is incorrect, adjust it as follows. **NOTICE: Improper drive chain slack will overload the engine as well as other vital parts of the motorcycle and can lead to chain slippage or breakage. To prevent this from occurring, keep the drive chain slack within the specified limits.** [ECA10572]

Periodic maintenance and adjustment

EAU84060

To adjust the drive chain slack

Consult a Yamaha dealer before adjusting the drive chain slack.

1. Loosen the axle nut and the locknut on each side of the swingarm.

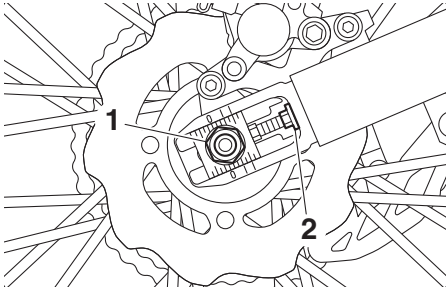

1. Axle nut
2. Locknut

2. To tighten the drive chain, turn the drive chain slack adjusting bolt on each side of the swingarm in direction (a). To loosen the drive chain, turn the adjusting bolt on each side of the swingarm in direction (b), and then push the rear wheel forward.

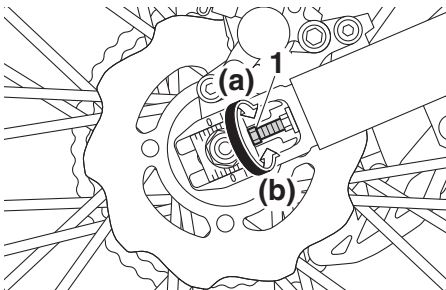

1. Drive chain slack adjusting bolt

TIP

Using the alignment marks on the drive chain pullers and the notch on each side of the swingarm, make sure that both drive chain pullers are in the same position for proper wheel alignment.

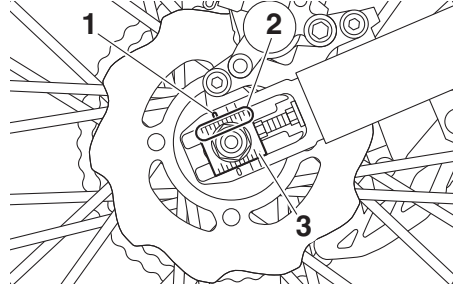

1. Notch
2. Alignment mark
3. Drive chain puller

3. Tighten both locknuts and the axle nut to the specified torques.

Tightening torques:

- Locknut:
21 N·m (2.1 kgf·m, 15 lb·ft)
Axle nut:
80 N·m (8.0 kgf·m, 59 lb·ft)

4. Make sure that the drive chain pullers are in the same position, the drive chain slack is correct, and the drive chain moves smoothly.

Periodic maintenance and adjustment

Cleaning and lubricating the drive chain

EAU23018

The drive chain must be cleaned and lubricated at the intervals specified in the periodic maintenance and lubrication chart, otherwise it will quickly wear out, especially when riding in dusty or wet areas. Service the drive chain as follows.

NOTICE

ECA10584

The drive chain must be lubricated after washing the motorcycle, riding in the rain or riding in wet areas.

1. Remove all dirt and mud from the drive chain with a brush or cloth.

TIP

For a thorough cleaning, have a Yamaha dealer remove the drive chain and soak it in solvent.

2. Spray Yamaha chain lubricant or other suitable chain lubricant on the entire chain, making sure that all side plates and rollers have been sufficiently oiled.

Checking and lubricating the cables

EAU23098

The operation of all control cables and the condition of the cables should be checked before each ride, and the cables and cable ends should be lubricated if necessary. If a cable is damaged or does not move smoothly, have a Yamaha dealer check or replace it. **WARNING! Damage to the outer housing of cables may result in internal rusting and cause interference with cable movement. Replace damaged cables as soon as possible to prevent unsafe conditions.** [EWA10712]

Recommended lubricant:

Yamaha cable lubricant or other suitable cable lubricant

Periodic maintenance and adjustment

Checking and lubricating the throttle grip and cable

EAU23115

The operation of the throttle grip should be checked before each ride. In addition, the cable should be lubricated by a Yamaha dealer at the intervals specified in the periodic maintenance chart.

The throttle cable is equipped with a rubber cover. Make sure that the cover is securely installed. Even though the cover is installed correctly, it does not completely protect the cable from water entry. Therefore, use care not to pour water directly onto the cover or cable when washing the vehicle. If the cable or cover becomes dirty, wipe clean with a moist cloth.

Checking and lubricating the brake and clutch levers

EAU23144

The operation of the brake and clutch levers should be checked before each ride, and the lever pivots should be lubricated if necessary.

Brake lever

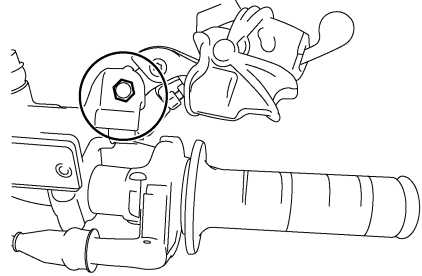

Clutch lever

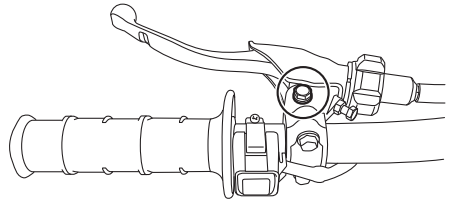

Recommended lubricants:

Brake lever:

Silicone grease

Clutch lever:

Lithium-soap-based grease

Periodic maintenance and adjustment

Checking and lubricating the brake pedal

EAU23185

The operation of the brake pedal should be checked before each ride, and the pedal pivot should be lubricated if necessary.

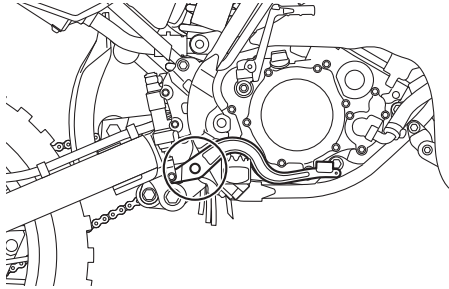

Recommended lubricant:
Lithium-soap-based grease

Lubricating the rear suspension

EAU85250

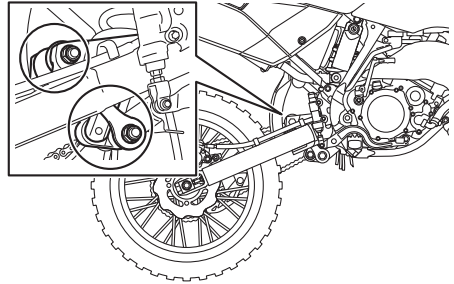

The pivoting points of the rear suspension must be lubricated by a Yamaha dealer at the intervals specified in the periodic maintenance and lubrication chart.

Recommended lubricant:
Molybdenum disulfide grease

Periodic maintenance and adjustment

EAUM2701

EAU23273

Lubricating the swingarm pivots

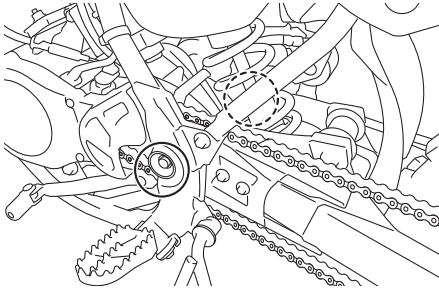

The swingarm pivots must be lubricated at the intervals specified in the periodic maintenance and lubrication chart.

Recommended lubricant:

Molybdenum disulfide grease

Checking the front fork

The condition and operation of the front fork must be checked as follows at the intervals specified in the periodic maintenance and lubrication chart.

To check the condition

Check the inner tubes for scratches, damage and excessive oil leakage.

To check the operation

1. Place the vehicle on a level surface and hold it in an upright position. **WARNING! To avoid injury, securely support the vehicle so there is no danger of it falling over.** [EWA10752]
2. While applying the front brake, push down hard on the handlebars several times to check if the front fork compresses and rebounds smoothly.

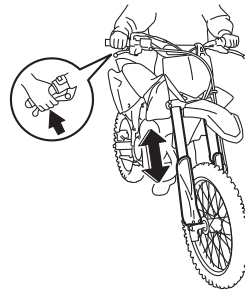

ECA10591

NOTICE

If any damage is found or the front fork does not operate smoothly, have a Yamaha dealer check or repair it.

Periodic maintenance and adjustment

EAU23285

Checking the steering

Worn or loose steering bearings may cause danger. Therefore, the operation of the steering must be checked as follows at the intervals specified in the periodic maintenance and lubrication chart.

1. Raise the front wheel off the ground. (See page 7-28.)

WARNING! To avoid injury, securely support the vehicle so there is no danger of it falling over. [EWA10752]

2. Hold the lower ends of the front fork legs and try to move them forward and backward. If any free play can be felt, have a Yamaha dealer check or repair the steering.

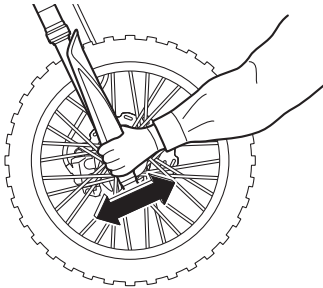

EAU23292

Checking the wheel bearings

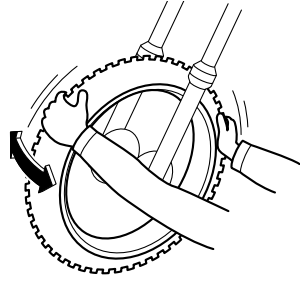

The front and rear wheel bearings must be checked at the intervals specified in the periodic maintenance and lubrication chart. If there is play in the wheel hub or if the wheel does not turn smoothly, have a Yamaha dealer check the wheel bearings.

Periodic maintenance and adjustment

Supporting the motorcycle

EAU75190

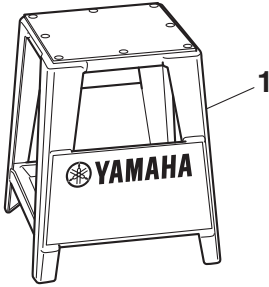

1. Maintenance stand (for off-road motorcycle)

Since this model is not equipped with a centerstand, use a maintenance stand when removing the front or rear wheel, adjusting the chain or washing the vehicle, etc.

Check that the motorcycle is in a stable and level position before starting any maintenance.

TIP

If a suitable maintenance stand is not available, a strong wooden box can be used instead.

Front wheel

EAU24361

EAU56372

To remove the front wheel

EWA10822

! WARNING

To avoid injury, securely support the vehicle so there is no danger of it falling over.

1. Loosen the axle nut.

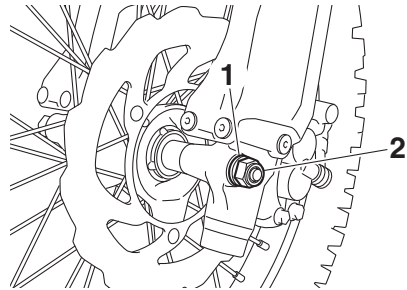

1. Washer
2. Axle nut

2. Place the motorcycle on a suitable stand. (See page 7-28.)
3. Remove the axle nut and washer.
4. Pull out the wheel axle.

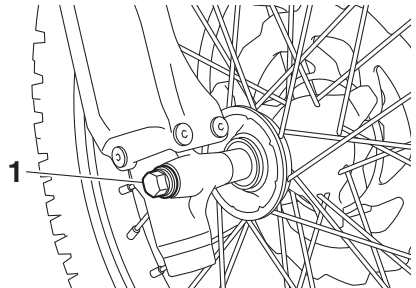

1. Wheel axle

Periodic maintenance and adjustment

5. Remove the wheel. **NOTICE: Do not apply the brake after the wheel and brake disc have been removed, otherwise the brake pads will be forced shut.** [ECA11073]

To install the front wheel

1. Make sure the brake pads have not been forced shut.
2. Lift up the wheel between the fork legs.
3. Insert the wheel axle from the right side.
4. Install the washer and axle nut.
5. Tighten the axle nut to the specified torque.

Tightening torque:

Axle nut:

70 N·m (7.0 kgf·m, 52 lb·ft)

Rear wheel

EAU25081

EAU84051

To remove the rear wheel

EWA10822



WARNING

To avoid injury, securely support the vehicle so there is no danger of it falling over.

1. Loosen the axle nut.

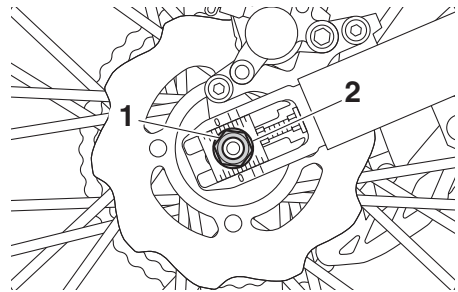

1. Axle nut
2. Washer

2. Place the motorcycle on a suitable stand. (See page 7-28.)
3. Loosen the locknut, and then turn the drive chain slack adjusting bolt in direction (a). Repeat for the other side.

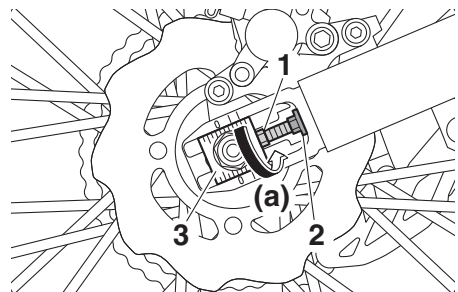

1. Drive chain slack adjusting bolt
2. Locknut
3. Drive chain puller

Periodic maintenance and adjustment

4. Remove the axle nut and washer.
5. Push the wheel forward and remove the drive chain from the rear sprocket.

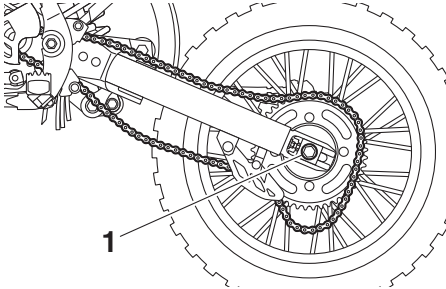

1. Wheel axle

6. While supporting the brake caliper bracket, pull out the wheel axle.

TIP

- A rubber mallet may be useful to tap the wheel axle out.
- The drive chain pullers may fall out when removing the wheel axle.

7. Remove the wheel. **NOTICE: Do not apply the brake after the wheel and brake disc have been removed, otherwise the brake pads will be forced shut.** [ECA11073]

TIP

- If the drive chain is difficult to remove, remove the wheel axle first.
- For easy installation, rest the drive chain on top of the swingarm.

To install the rear wheel

1. Make sure the brake pads have not been forced shut.
2. Install the wheel, the brake caliper bracket and drive chain pullers by inserting the wheel axle from the left side.

TIP

Make sure the slot in the brake caliper bracket is fit over the retainer on the swingarm.

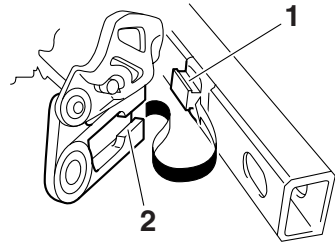

1. Retainer

2. Slot

3. Install the drive chain onto the rear sprocket.
4. Install the washer and axle nut.
5. Adjust the drive chain slack. (See page 7-21.)

Periodic maintenance and adjustment

EAU25872

Troubleshooting

Although Yamaha motorcycles receive a thorough inspection before shipment from the factory, trouble may occur during operation. Any problem in the fuel, compression, or ignition systems, for example, can cause poor starting and loss of power.

The following troubleshooting charts represent quick and easy procedures for checking these vital systems yourself. However, should your motorcycle require any repair, take it to a Yamaha dealer, whose skilled technicians have the necessary tools, experience, and know-how to service the motorcycle properly.

Use only genuine Yamaha replacement parts. Imitation parts may look like Yamaha parts, but they are often inferior, have a shorter service life and can lead to expensive repair bills.

EWA15142

WARNING

When checking the fuel system, do not smoke, and make sure there are no open flames or sparks in the area, including pilot lights from water heaters or furnaces. Gasoline or gasoline vapors can ignite or explode, causing severe injury or property damage.

Periodic maintenance and adjustment

EAU86410

Troubleshooting chart

1. Fuel

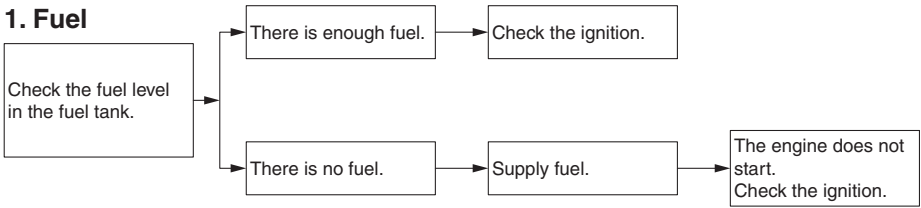

2. Ignition

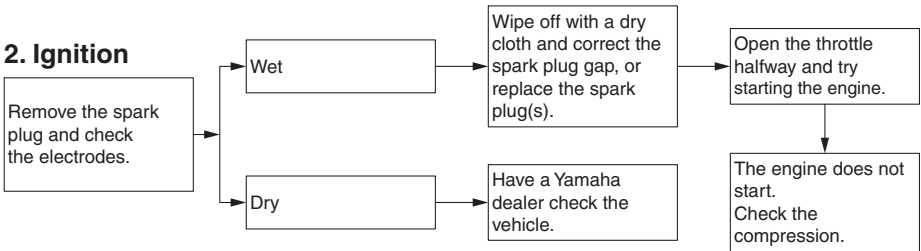

3. Compression

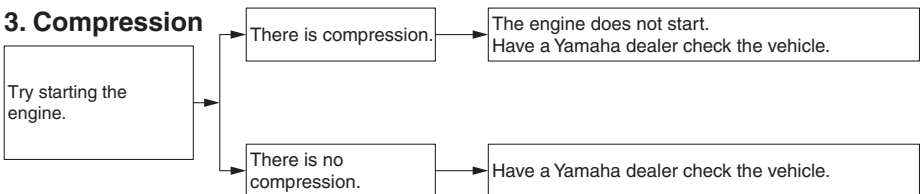

Periodic maintenance and adjustment

EAU86430

Engine overheating

EWAT1041

⚠ WARNING

- Do not remove the radiator cap when the engine and radiator are hot. Scalding hot fluid and steam may be blown out under pressure, which could cause serious injury. Be sure to wait until the engine has cooled.
- Place a thick rag, like a towel, over the radiator cap, and then slowly rotate the cap counterclockwise to the detent to allow any residual pressure to escape. When the hissing sound has stopped, press down on the cap while turning it counterclockwise, and then remove the cap.

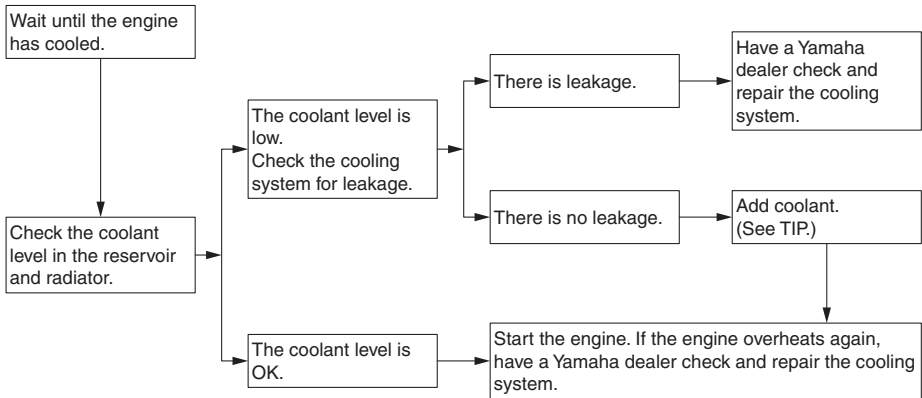

7

TIP

If coolant is not available, tap water can be temporarily used instead, provided that it is changed to the recommended coolant as soon as possible.

Matte color caution

EAU37834

EAU84432

NOTICE

ECA15193

Some models are equipped with matte colored finished parts. Be sure to consult a Yamaha dealer for advice on what products to use before cleaning the vehicle. Using a brush, harsh chemical products or cleaning compounds when cleaning these parts will scratch or damage their surface. Wax also should not be applied to any matte colored finished parts.

Care

Frequent, thorough cleaning of the vehicle will not only enhance its appearance but also will improve its general performance and extend the useful life of many components. Washing, cleaning, and polishing will also give you a chance to inspect the condition of the vehicle more frequently. Be sure to wash the vehicle after riding in the rain or near the sea, because salt is corrosive to metals.

TIP

- The roads of heavy snowfall areas may be sprayed with salt as a de-icing method. This salt can stay on the roads well into spring, so be sure to wash the underside and chassis parts after riding in such areas.
- Genuine Yamaha care and maintenance products are sold under the YAMALUBE brand.

ECA26280

NOTICE

Improper cleaning can cause cosmetic and mechanical damage. Do not use:

- high-pressure washers or steam-jet cleaners. Excessive water pressure may cause water seepage and deterioration of wheel bearings, brakes, transmission seals and electrical devices. Avoid high-pressure detergent applications such as those available in coin-operated car washers.

Motorcycle care and storage

- harsh chemicals, including strong acidic wheel cleaners, especially on spoke or magnesium wheels.
- harsh chemicals, abrasive cleaning compounds, or wax on matte-finished parts. Brushes can scratch and damage the matte-finish, use soft sponge or towel only.
- towels, sponges, or brushes contaminated with abrasive cleaning products or strong chemicals such as, solvents, gasoline, rust removers, brake fluid, or antifreeze, etc.

Before washing

1. Park the vehicle out of direct sunlight and allow it to cool. This will help avoid water spots.
2. Make sure all caps, covers, electrical couplers and connectors are tightly installed.
3. Cover the muffler end with a plastic bag and a strong rubber band.
4. Pre-soak stubborn stains like insects or bird droppings with a wet towel for a few minutes.
5. Remove road grime and oil stains with a biodegradable degreaser (YAMACLEAN Pro-Wash Spray) and a plastic-bristle brush or sponge. **NOTICE: Do not use degreasing agent on areas requiring lubrication such as seals, gaskets, and wheel axles. Follow product instructions.**

[ECA26290]

Washing

1. Rinse off any degreaser and spray down the vehicle with a garden hose. Use only enough pressure to do the job. Avoid spraying water directly into the muffler, instrument panel, air inlet, or other inner areas such as underseat storage compartments.
2. Wash the vehicle with a quality automotive-type detergent (YAMALUBE Wash & Wax) mixed with cool water and a soft, clean towel or sponge. Use an old toothbrush or plastic-bristle brush for hard-to-reach places. **NOTICE: Use cold water if the vehicle has been exposed to salt. Warm water will increase salt's corrosive properties.** [ECA26301]
3. For windshield-equipped vehicles: Clean the windshield with a soft towel or sponge dampened with water and a pH neutral detergent. If necessary, use a high-quality windshield cleaner (YAMACLEAN Glass Cleaner) or windshield polish. **NOTICE: Never use any strong chemicals to clean the windshield. Additionally, some cleaning compounds for plastic may scratch the windshield, so be sure to test all cleaning products before general application.** [ECA26310]
4. Rinse off thoroughly with clean water. Be sure to remove all detergent residues, as they can be harmful to plastic parts.

Motorcycle care and storage

After washing

1. Dry the vehicle with a chamois or absorbent towel, preferably microfiber terrycloth.
2. For drive chain-equipped models, dry and then lubricate it to prevent rust.
3. Use a chrome polish to shine chrome, aluminum, and stainless steel parts. Often the thermally induced discoloring of stainless steel exhaust systems can be removed through polishing.
4. Apply a corrosion protection spray (YAMALUBE Silicone Protectant & Lubricant) on all metal parts including chrome or nickel-plated surfaces. **WARNING! Do not apply silicone or oil spray to seats, hand grips, rubber foot pegs or tire treads. Otherwise these parts will become slippery, which could cause loss of control. Thoroughly clean the surfaces of these parts before operating the vehicle.** [EWA20650]
5. Treat rubber, vinyl, and unpainted plastic parts with a suitable care product (YAMACLEAN Vinyl Dressing).
6. Touch up minor paint damage caused by stones, etc.
7. Wax all painted surfaces using a non-abrasive wax or use a detail spray for motorcycles (YAMALUBE Spray Polish & Instant Detailer).
8. When finished cleaning, start the engine and let it idle for several minutes to help dry any remaining moisture.
9. If the headlight lens has fogged up, start the engine and turn on the headlight to help remove the moisture.
10. Let the vehicle dry completely before storing or covering it.

ECA26320

NOTICE

- Do not apply wax to rubber or unpainted plastic parts.
- Do not use abrasive polishing compounds as they will wear away the paint.
- Apply sprays and wax sparingly. Wipe off excess afterwards.

EWA20660

WARNING

Contaminants left on the brakes or tires can cause loss of control.

- Make sure there is no lubricant or wax on the brakes or tires.
- If necessary, wash the tires with warm water and a mild detergent.
- If necessary, clean the brake discs and pads with brake cleaner or acetone.
- Before riding at higher speeds, test the vehicle's braking performance and cornering behavior.

Motorcycle care and storage

EAU84440

Storage

Always store the vehicle in a cool, dry place. If necessary, protect it against dust with a porous cover. Be sure the engine and the exhaust system are cool before covering the vehicle. If the vehicle often sits for weeks at a time between uses, the use of a quality fuel stabilizer (Fuel Med RX) is recommended after each fill-up.

ECA21170

NOTICE

- **Storing the vehicle in a poorly ventilated room or covering it with a tarp, while it is still wet, will allow water and humidity to seep in and cause rust.**
- **To prevent corrosion, avoid damp cellars, stables (because of the presence of ammonia) and areas where strong chemicals are stored.**

8

Long term storage

Before storing the vehicle long term (60 days or more):

1. Make all necessary repairs and perform any outstanding maintenance.
2. Follow all instructions in the Care Section of this chapter.
3. Fill up the fuel tank and add fuel stabilizer according to product instructions.
4. Run the engine for 5 minutes to distribute treated fuel through the fuel system.
5. For vehicles with a fuel cock: Turn the fuel cock lever to the off position.

6. For vehicles with a carburetor: To prevent fuel deposits from building up, drain the fuel in the carburetor float chamber into a clean container. Retighten the drain bolt and pour the fuel back into the fuel tank.
7. Use a quality engine fogging oil (YAMALUBE Stor-Rite Engine Fogging Oil) according to product instructions. If engine fogging oil is not available, perform the following steps for each cylinder:
 - a. Remove the spark plug cap and spark plug.
 - b. Pour a teaspoonful of engine oil into the spark plug bore.
 - c. Install the spark plug cap onto the spark plug, and then place the spark plug on the cylinder head so that the electrodes are grounded. (This will limit sparking during the next step.)
 - d. Turn the engine over several times with the starter or kick-starter. (This will coat the cylinder wall with oil.) **WARNING! To prevent damage or injury from sparking, make sure to ground the spark plug electrodes while turning the engine over.** [EWA10952]
 - e. Remove the spark plug cap from the spark plug, and then install the spark plug and the spark plug cap.
8. Lubricate all control cables, pivots, levers and pedals, as well as the sidestand and centerstand (if equipped).

Motorcycle care and storage

9. Check and correct the tire air pressure, and then lift the vehicle so that all wheels are off the ground. If maintenance stands are not available, turn the wheels a little once a month in order to prevent the tires from becoming degraded in one spot.
10. Cover the muffler outlet with a plastic bag to prevent moisture from entering it.
11. For vehicles with a battery: Remove and fully charge it, or attach a maintenance charger. **NOTICE: Confirm that the battery and its charger are compatible. Do not charge a VRLA battery with a conventional charger.** [ECA26330]

Specifications

Dimensions:

- Overall length:
1820 mm (71.7 in)
- Overall width:
760 mm (29.9 in)
- Overall height:
1145 mm (45.1 in)
- Seat height:
840 mm (33.1 in)
- Wheelbase:
1255 mm (49.4 in)
- Ground clearance:
330 mm (12.99 in)

Weight:

- Curb weight:
73 kg (161 lb)

Engine:

- Combustion cycle:
2-stroke
- Cooling system:
Liquid cooled
- Number of cylinders:
Single cylinder
- Displacement:
85 cm³
- Bore × stroke:
47.5 × 47.8 mm (1.87 × 1.88 in)
- Starting system:
Kickstarter

Engine oil:

- Engine oil:
YAMALUBE 2R
- Recommended brand:



Transmission oil:

- Type:
Motor oil SAE 10W-30 type SE or higher or
Gear oil SAE 85W GL-3
- Quantity:
0.50 L (0.53 US qt, 0.44 Imp.qt)

Coolant quantity:

- Radiator (including all routes):
0.55 L (0.58 US qt, 0.48 Imp.qt)

Fuel:

- Recommended fuel:
Unleaded gasoline (E10 acceptable)

- Octane number (RON):
98
- Fuel tank capacity:
5.0 L (1.3 US gal, 1.1 Imp.gal)

Carburetor:

- Type × quantity:
PWK28 × 1

Drivetrain:

- Gear ratio:
1st:
2.455 (27/11)
2nd:
1.882 (32/17)
3rd:
1.529 (26/17)
4th:
1.294 (22/17)
5th:
1.130 (26/23)
6th:
1.000 (25/25)

Front tire:

- Type:
With tube
- Size:
70/100-17 40M
- Manufacturer/model:
DUNLOP/MX3SF

Rear tire:

- Type:
With tube
- Size:
90/100-14 49M
- Manufacturer/model:
DUNLOP/MX3S

Front brake:

- Type:
Hydraulic single disc brake

Rear brake:

- Type:
Hydraulic single disc brake

Front suspension:

- Type:
Telescopic fork

Rear suspension:

- Type:
Swingarm (link suspension)

Identification numbers

EAU26366

Record the vehicle identification number and the engine serial number in the spaces provided below for assistance when ordering spare parts from a Yamaha dealer or for reference in case the vehicle is stolen.

VEHICLE IDENTIFICATION NUMBER:

ENGINE SERIAL NUMBER:

Vehicle identification number

EAU26401

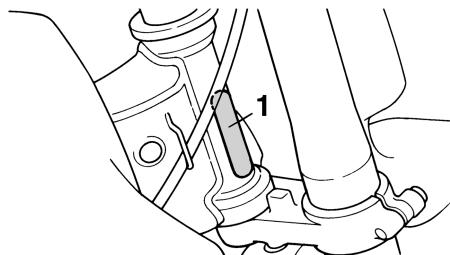

1. Vehicle identification number

The vehicle identification number is stamped into the steering head pipe. Record this number in the space provided.

TIP

The vehicle identification number is used to identify your motorcycle and may be used to register your motorcycle with the licensing authority in your area.

Engine serial number

EAU26442

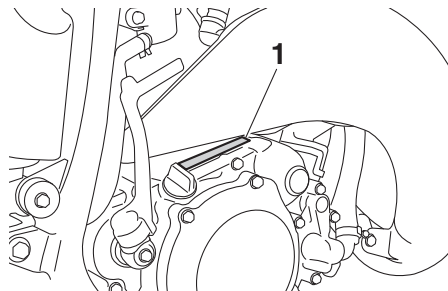

1. Engine serial number

The engine serial number is stamped into the crankcase.

Consumer information

EAU68862

YAMAHA MOTOR CORPORATION, U.S.A. 2020 AND LATER MODEL YZ/WR MOTORCYCLE LIMITED WARRANTY

Yamaha Motor Corporation, U.S.A. hereby warrants to the original retail purchaser that the following components equipped on new Yamaha YZ or WR motorcycles purchased from an authorized Yamaha motorcycle dealer in the continental United States will be free from defects in material and workmanship for the period of time stated herein, subject to certain stated limitations. YZ or WR components included under this warranty are the engine, frame, swingarm, and monoshock. It is understood that the balance of the YZ or WR components are not covered by any warranty, expressed or implied. The balance of the components equipped on the unit are sold on an "as is" basis. This warranty applies to the original purchaser only and is not transferable.

THE PERIOD OF WARRANTY for the above-listed Yamaha YZ or WR components as originally installed on the unit shall be thirty (30) days from the date of purchase.

DURING THE PERIOD OF WARRANTY any authorized Yamaha motorcycle dealer will, free of charge, repair or replace, at Yamaha's option, any part adjudged defective by Yamaha due to faulty workmanship or material from the factory. Parts used in warranty repairs will be warranted for the balance of the product's warranty period. All parts replaced under warranty become property of Yamaha Motor Corporation, U.S.A.

GENERAL EXCLUSIONS from this warranty shall include any failures caused by:

- a. Installation of parts or accessories that are not qualitatively equivalent to genuine Yamaha parts.
- b. Abnormal strain, neglect, or abuse.
- c. Accident or collision damage.
- d. Modification to original parts.
- e. Lack of proper maintenance.
- f. Damage due to improper transportation.

SPECIFIC EXCLUSIONS from this warranty shall include parts replaced due to normal wear or routine maintenance.

THE CUSTOMER'S RESPONSIBILITY under this warranty shall be to:

1. Operate and maintain the YZ or WR as specified in the appropriate Owner's Service Manual, and
2. Give notice to an authorized Yamaha motorcycle dealer of any and all apparent defects within ten (10) days after discovery, and make the machine available at that time for inspection and repairs at such dealer's place of business.

EMISSION CONTROL SYSTEM WARRANTY

Yamaha Motor Corporation, U.S.A. also warrants to the ultimate purchaser and each subsequent purchaser of each 2006 and later model Yamaha WR motorcycle covered by this warranty that the vehicle is designed, built, and equipped so as to conform at the time of sale with all U.S. emissions standards applicable at the time of manufacture and that it is free from defects in materials and workmanship which would cause it not to meet these standards within the period listed immediately below. Failures other than those resulting from defects in material or workmanship which arise solely as a result of owner abuse and/or lack of proper maintenance are not covered by this warranty. YZ models are closed-course use only and are not regulated, and are therefore not covered by this Emission Control System warranty.

All 2006 and Later WR Models

Thirty (30) months from the original purchase date

YAMAHA MOTOR CORPORATION, U.S.A. MAKES NO OTHER WARRANTY OF ANY KIND, EXPRESSED OR IMPLIED. ALL IMPLIED WARRANTIES OF MERCHANTABILITY AND FITNESS FOR A PARTICULAR PURPOSE WHICH EXCEED THE OBLIGATIONS AND TIME LIMITS STATED IN THIS WARRANTY ARE HEREBY DISCLAIMED BY YAMAHA MOTOR CORPORATION, U.S.A. AND EXCLUDED FROM THIS WARRANTY.

SOME STATES DO NOT ALLOW LIMITATIONS ON HOW LONG AN IMPLIED WARRANTY LASTS, SO THE ABOVE LIMITATION MAY NOT APPLY TO YOU. ALSO EXCLUDED FROM THIS WARRANTY ARE ANY INCIDENTAL OR CONSEQUENTIAL DAMAGES INCLUDING LOSS OF USE. SOME STATES DO NOT ALLOW THE EXCLUSION OR LIMITATION OF INCIDENTAL OR CONSEQUENTIAL DAMAGES, SO THE ABOVE EXCLUSION MAY NOT APPLY TO YOU.

THIS WARRANTY GIVES YOU SPECIFIC LEGAL RIGHTS, AND YOU MAY ALSO HAVE OTHER RIGHTS WHICH VARY FROM STATE TO STATE.

YAMAHA MOTOR CORPORATION, U.S.A.
Post Office Box 6555
Cypress, California 90630
1-800-962-7926

Consumer information

WARRANTY QUESTIONS AND ANSWERS

Q. What costs are my responsibility during the warranty period?

A. The customer's responsibility includes all costs of normal maintenance services, non-warranty repairs, accident and collision damage, and oil, oil filters, air filters, spark plugs, and brake shoes or pads.

Q. What are some examples of "abnormal" strain, neglect, or abuse?

A. These terms are general and overlap each other in areas. Specific examples include: Running the machine without oil; operating the machine with a broken or damaged part which causes another part to fail, damage or failure due to improper or, careless transportation and or tie down; and so on. If you have any specific questions on operation or maintenance, please contact your dealer for advice.

Q. Does the warranty cover incidental costs such as towing or transportation due to a failure?

A. No. The warranty is limited to repair of the machine itself.

Q. May I perform any or all of the recommended maintenance shown in the Owner's Service Manual instead of having the dealer do them?

A. Yes, if you are a qualified mechanic and follow the procedures specified in the Owner's Service Manual. We do recommend, however, that items requiring special tools or equipment be done by a Yamaha motorcycle dealer.

Q. Will the warranty be void or canceled if I do not operate or maintain my new YZ or WR exactly as specified in the Owner's Service Manual?

A. No. The warranty on a new motorcycle cannot be "voided" or "cancelled." **However, if a particular failure is caused by operation or maintenance other than as shown in the Owner's Service Manual, that failure may not be covered under warranty.**

Q. What responsibility does my dealer have under this warranty?

A. Each Yamaha motorcycle dealer is expected to:

1. Completely set up every new machine before sale.

2. Explain the operation, maintenance, and warranty requirements to your satisfaction at the time of sale, and upon your request at any later date.

In addition, each Yamaha motorcycle dealer is held responsible for his setup, service and warranty repair work.

Q. Does the warranty on the engine include the carburetor, air filter, air box, and exhaust pipe?

A. No. The warranty covers only the engine components.

CUSTOMER SERVICE

If your machine requires warranty service, you must take it to any authorized Yamaha motorcycle dealer within the continental United States. Be sure to bring your warranty registration identification or other valid proof of the original date of purchase. If a question or problem arises regarding warranty, first contact the owner of the dealer-ship. Since all warranty matters are handled at the dealer level, this person is in the best position to help you. If you are still not satisfied and require additional assistance, please write:

YAMAHA MOTOR CORPORATION U.S.A.
CUSTOMER RELATIONS DEPARTMENT
P.O. Box 6555
Cypress, California 90630

When contacting Yamaha Motor Corporation, U.S.A. don't forget to include any important information such as names, addresses, model, VIN (vehicle identification number), dates, and receipts.

CHANGE OF ADDRESS

The federal government requires each manufacturer of a motor vehicle to maintain a complete, up-to-date list of all first purchasers against the possibility of a safety-related defect and recall. This list is compiled from the purchase registrations sent to Yamaha Motor Corporation, U.S.A. by the selling dealer at the time of your purchase.

If you should move after you have purchased your new motorcycle, please advise us of your new address by sending a postcard listing your motorcycle model name, VIN number, dealer number (or dealer's name) as it is shown on your warranty identification, your name and new mailing address.

Mail to:

YAMAHA MOTOR CORPORATION, U.S.A.
WARRANTY DEPARTMENT
1270 Chastain Road
Kennesaw, GA 30144

This will ensure that Yamaha Motor Corporation, U.S.A. has an up-to-date registration record in accordance with federal law.

Index

- A**
 - Air filter element, cleaning 7-10
- B**
 - Brake and clutch levers, checking and lubricating 7-24
 - Brake fluid, changing 7-21
 - Brake fluid level, checking 7-20
 - Brake lever 4-2
 - Brake lever free play, checking 7-18
 - Brake pedal 4-3
 - Brake pedal, checking and lubricating 7-25
- C**
 - Cables, checking and lubricating 7-23
 - Carburetor, adjusting 7-12
 - Care 8-1
 - Clutch lever 4-1
 - Clutch lever free play, adjusting 7-17
 - Coolant 7-8
- D**
 - Drive chain, cleaning and lubricating 7-23
 - Drive chain slack 7-21
- E**
 - Engine break-in 6-1
 - Engine idling speed 7-13
 - Engine overheating 7-33
 - Engine serial number 10-1
 - Engine, starting a warm 6-3
 - Engine stop switch 4-1
- F**
 - Front and rear brake pads, checking 7-19
 - Front fork, adjusting 4-9
 - Front fork, bleeding 4-11
 - Front fork, checking 7-26
 - Fuel 4-4
 - Fuel cock 4-7
 - Fuel tank breather hose 4-6
 - Fuel tank cap 4-3
- H**
 - Handlebar switch 4-1
- I**
 - Identification numbers 10-1
- K**
 - Kickstarter 4-8
- L**
 - Labels, location 1-1
- M**
 - Matte color, caution 8-1
- P**
 - Parking 6-5
 - Part locations 3-1
 - Periodic maintenance and lubrication chart 7-2
- R**
 - Rear suspension, lubricating 7-25
- S**
 - Safety information 2-1
 - Seat 4-8
 - Shifting 6-4
 - Shift pedal 4-2
 - Shift pedal, checking 7-18
 - Shock absorber assembly, adjusting ... 4-12
 - Sidestand 4-15
 - Spark plug, checking 7-6
 - Specifications 9-1
 - Starter (choke) knob 4-7
 - Starting and warming up a cold engine 6-3
 - Steering, checking 7-27
 - Storage 8-4
 - Supporting the motorcycle 7-28
 - Swingarm pivots, lubricating 7-26
- T**
 - Throttle grip and cable, checking and lubricating 7-24
 - Throttle grip free play, adjusting 7-13
 - Tires 7-14
 - Transmission oil 7-7
 - Troubleshooting 7-31
 - Troubleshooting chart 7-32
- V**
 - Vehicle identification number 10-1
- W**
 - Warranty, limited 10-2
 - Wheel bearings, checking 7-27
 - Wheel (front) 7-28
 - Wheel (rear) 7-29
 - Wheels 7-16
- Y**
 - YPVS system 4-16

For your best ownership experience, think **Genuine Yamaha!**

Genuine Yamaha Parts – Genuine Yamaha replacement parts are the exact same parts as the ones originally equipped on your vehicle, providing you with the performance and durability you have come to expect. Why settle for aftermarket parts that may not provide full confidence and satisfaction?

Genuine Yamaha Accessories – Yamaha only offers accessories that meet our high standards for quality and performance. Buy with confidence, knowing your Genuine Yamaha Accessories will fit right and perform right – right out of the box.

Yamalube – Take care of your Yamaha with legendary Yamalube oils, lubricants, and care products. They're formulated and approved by the toughest judges we know: the Yamaha engineering teams that know your Yamaha from the inside out.

Genuine Yamaha Service Manuals – Get the same factory manual for your vehicle that the technicians at your authorized Yamaha dealer use. Service manuals are available through your Yamaha dealer or you can order them directly through yamahapubs.com (for US consumers only).

Genuine Yamaha products are available only from your Yamaha dealer.

Find out more at:

For US consumers, please visit yamaha-motor.com

For Canadian consumers, please visit yamaha-motor.ca



PRINTED ON RECYCLED PAPER

PRINTED IN JAPAN
2019.03-0.3x1 CR
(E)